

SN03D12-502AM-M (Order no. 086585)

Series SN...AM, 12 mm, mechanical, with exterior diaphragm

- ▶ With exterior diaphragm
- ▶ Plunger spacing 12 mm
- ▶ Upright housing, small flange
- ▶ Degree of protection IP67 according to IEC 60529



Exterior diaphragm

The exterior diaphragm protects the plunger guide against the entry of very fine dust (dust from grinding, casting, glass, etc.) and prevents the plunger from seizing. At the same time, plunger sticking, caused by resinous lubricating coolants, can be prevented with this exterior diaphragm version.

Switching element

ES 502 E Snap-action switching contact 1 NC + 1 NO

Dimensional drawings

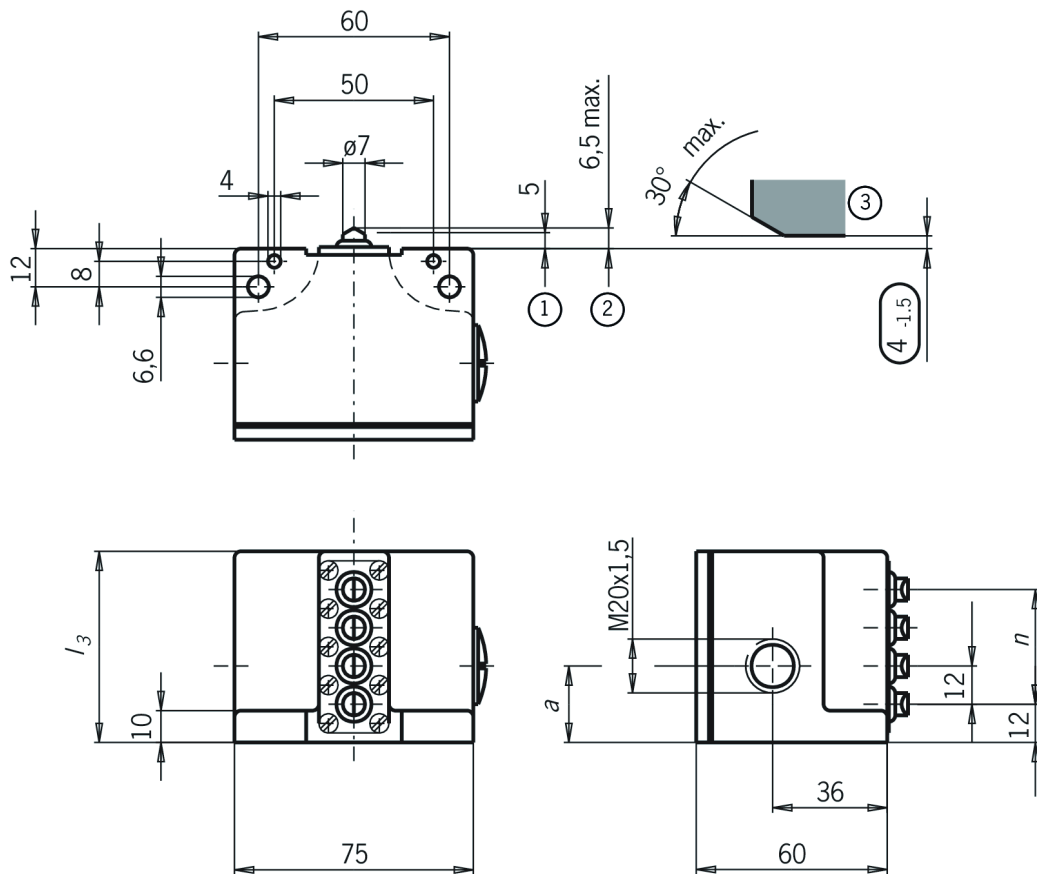

6	84	24
5	72	24
4	60	24
3	48	24
2	36	19
n Anzahl der Stößel	13	a
④		

1 Operating point

2 Free position

3 Dog

4 n Number of plungers

Connection examples

ES 502 E

