

## CES-A-LNA-10P-077807 (Order no. 077807)

### Read head CES-A-LNA..., hard-wired encapsulated cable 10 m, PUR

- ▶ Cube-shaped design 42 x 25 mm
- ▶ Hard-wired encapsulated cable made of PUR
- ▶ Cable length 10 m
- ▶ Two safety screws M4x14 included

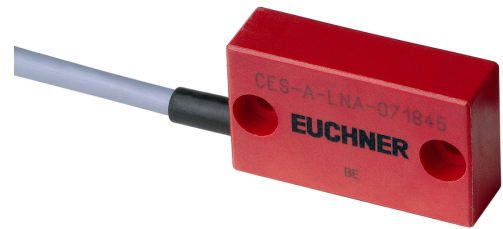

### Combination options

Suitable for connection to a CES-AZ evaluation unit

### Housing material

Fortron, reinforced thermoplastic, fully encapsulated.

**Attention:** The actuating range may vary depending on the substrate material and installation situation.

**Important:** Actuators must be ordered separately!

### Typical operating distance

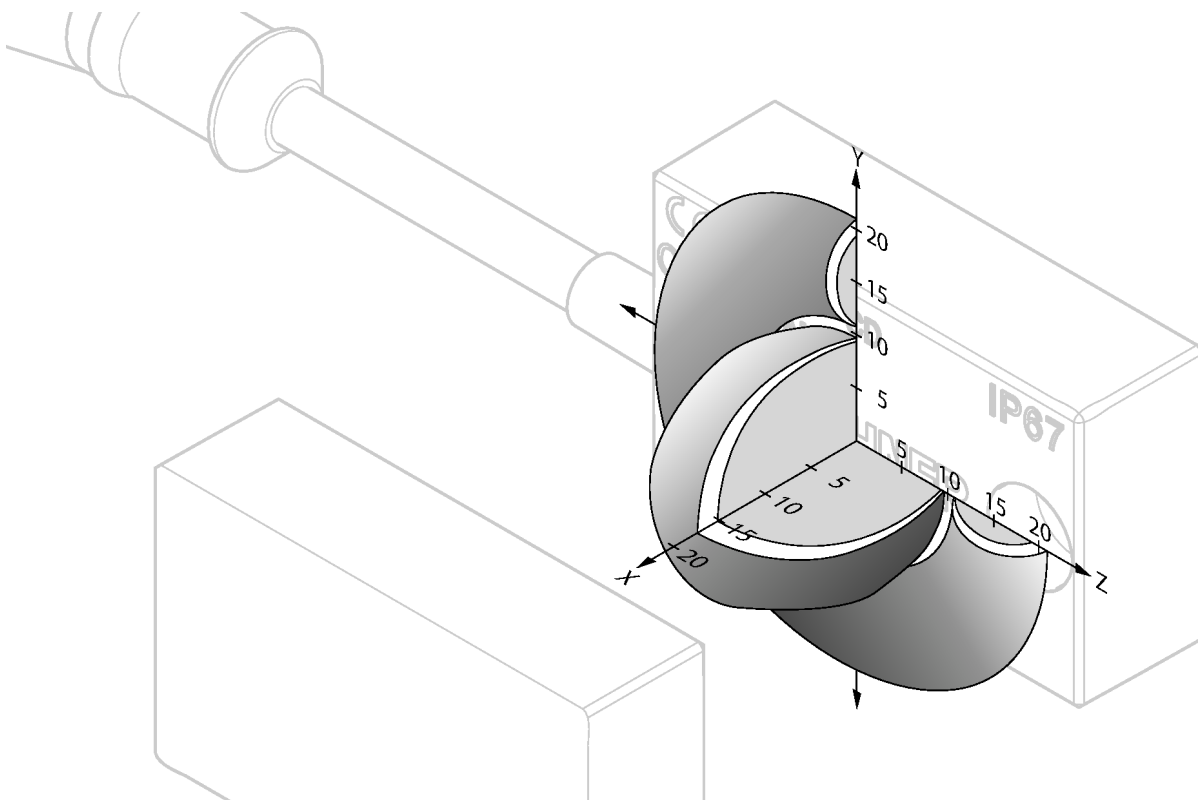

For a side approach direction for the actuator and read head, a minimum distance of  $s = 3$  mm must be maintained so that the actuating range of the side lobes is not entered.

## Dimensional drawings

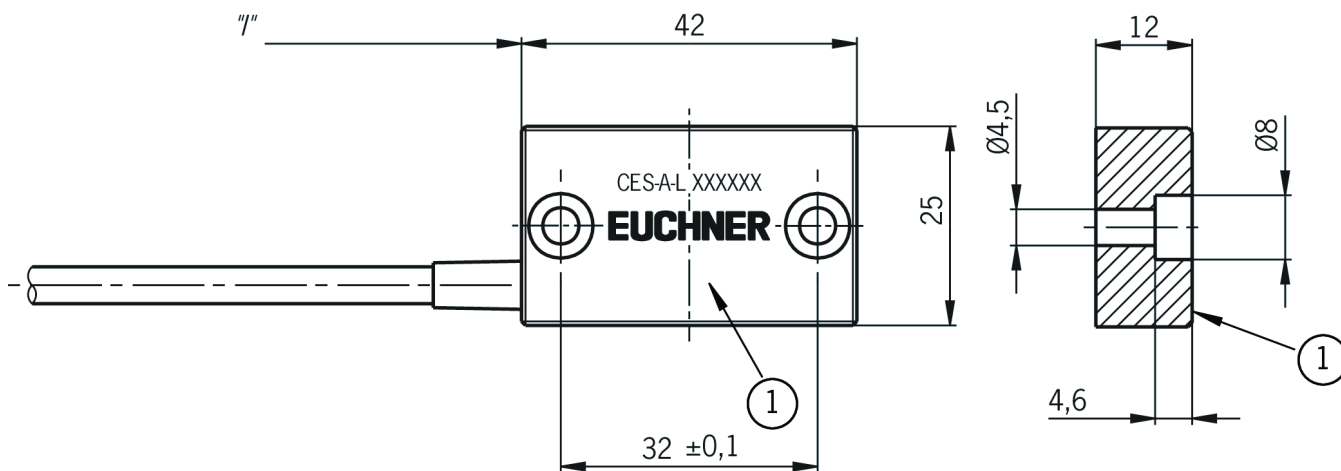

1 Active face

## Connection examples

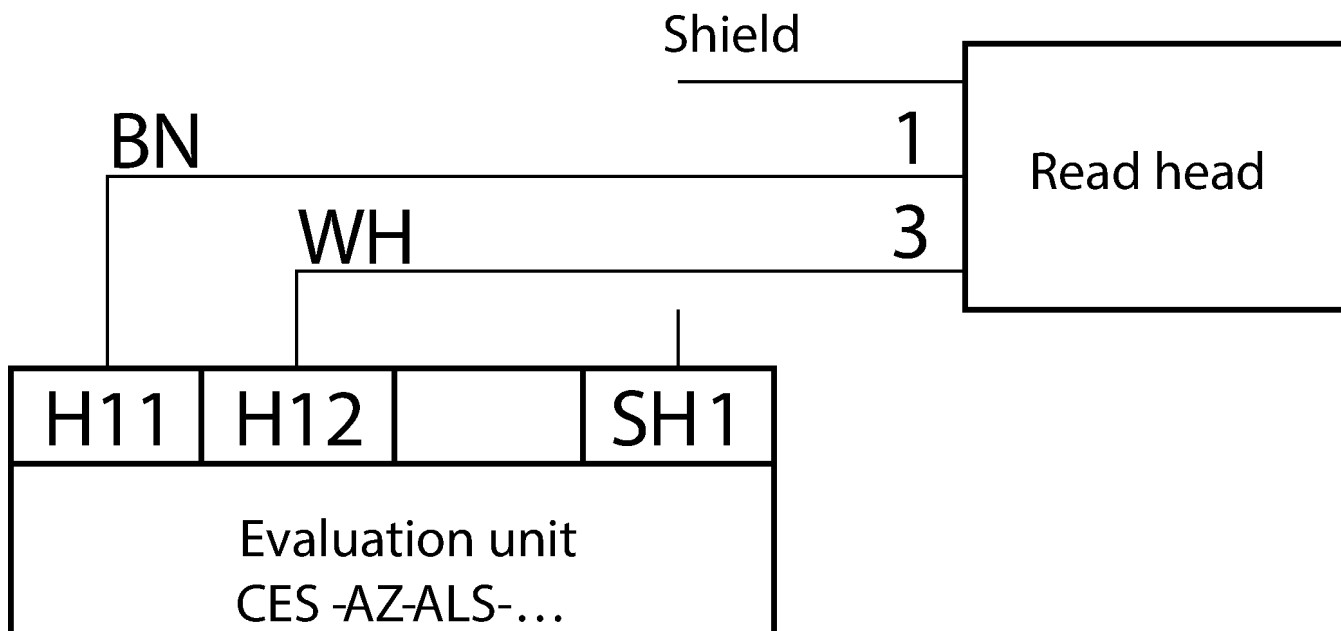

## Technical data

### Approvals



### Electrical connection values

Connecting cable	PUR (suitable for drag chain), length 10m, Ø 4.1...5.3 mm, with crimped ferrules
Power supply	Via evaluation unit

### Mechanical values and environment

Connection type	hard-wired encapsulated connecting cable
Tightening torque	
Fixing screws	max. 1 Nm
Installation orientation	any
Storage temperature	-25 ... 70 °C
Cable length	
maximum allowed	max. 25 m
Degree of protection	IP67/IP69K
Cable ambient temperature (dynamic)	-5 ... 70 °C
Cable ambient temperature (static)	-25 ... 70 °C
Material	
Housing	Reinforced thermoplastic (PPS), fully encapsulated
Method of operation	inductive