

## GSBF02D08-552-M (Order no. 085983)

### Series GSBF... 8 mm, mechanical

- ▶ Plunger spacing 8 mm
- ▶ Upright housing
- ▶ Degree of protection IP67 according to IEC 60529



### Switching element

ES 552 Snap-action switching contact 1 changeover contact standard switching element

### Dimensional drawings

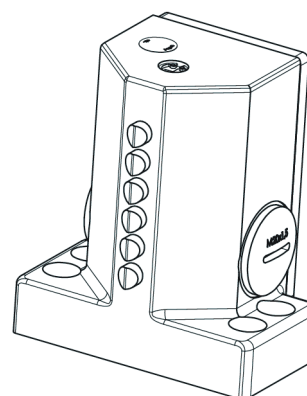
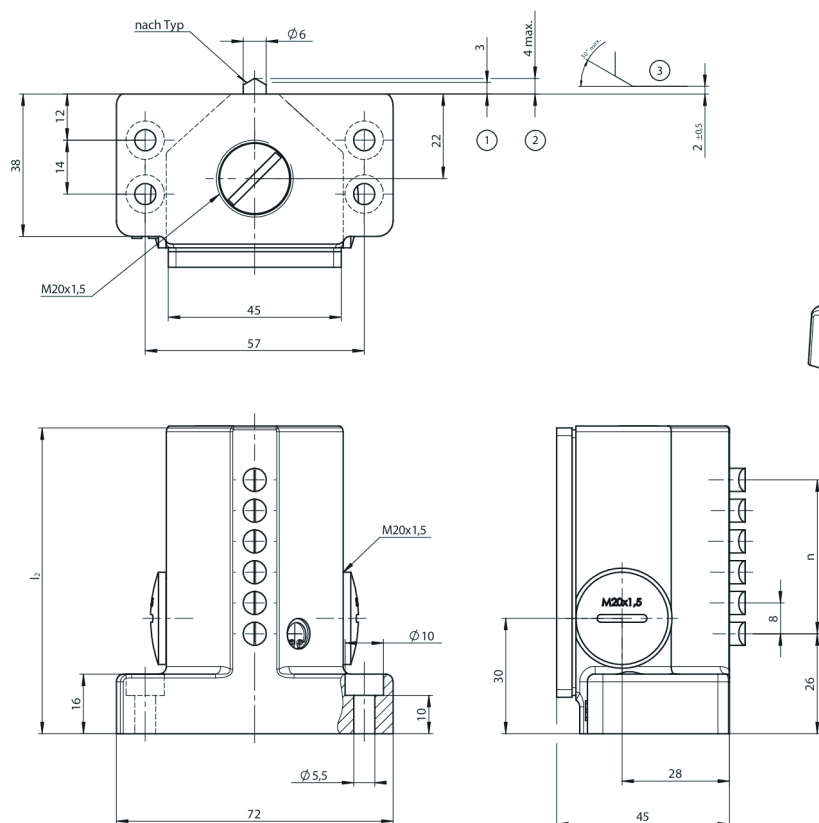

20	192
18	176
16	160
14	144
12	128
10	112
8	96
6	80
5	80
4	64
3	64
2	48
n Anzahl der Stoessel	l <sub>2</sub>

1 Operating point

2 Free position

3 Dog

Connection examples

# ES 552

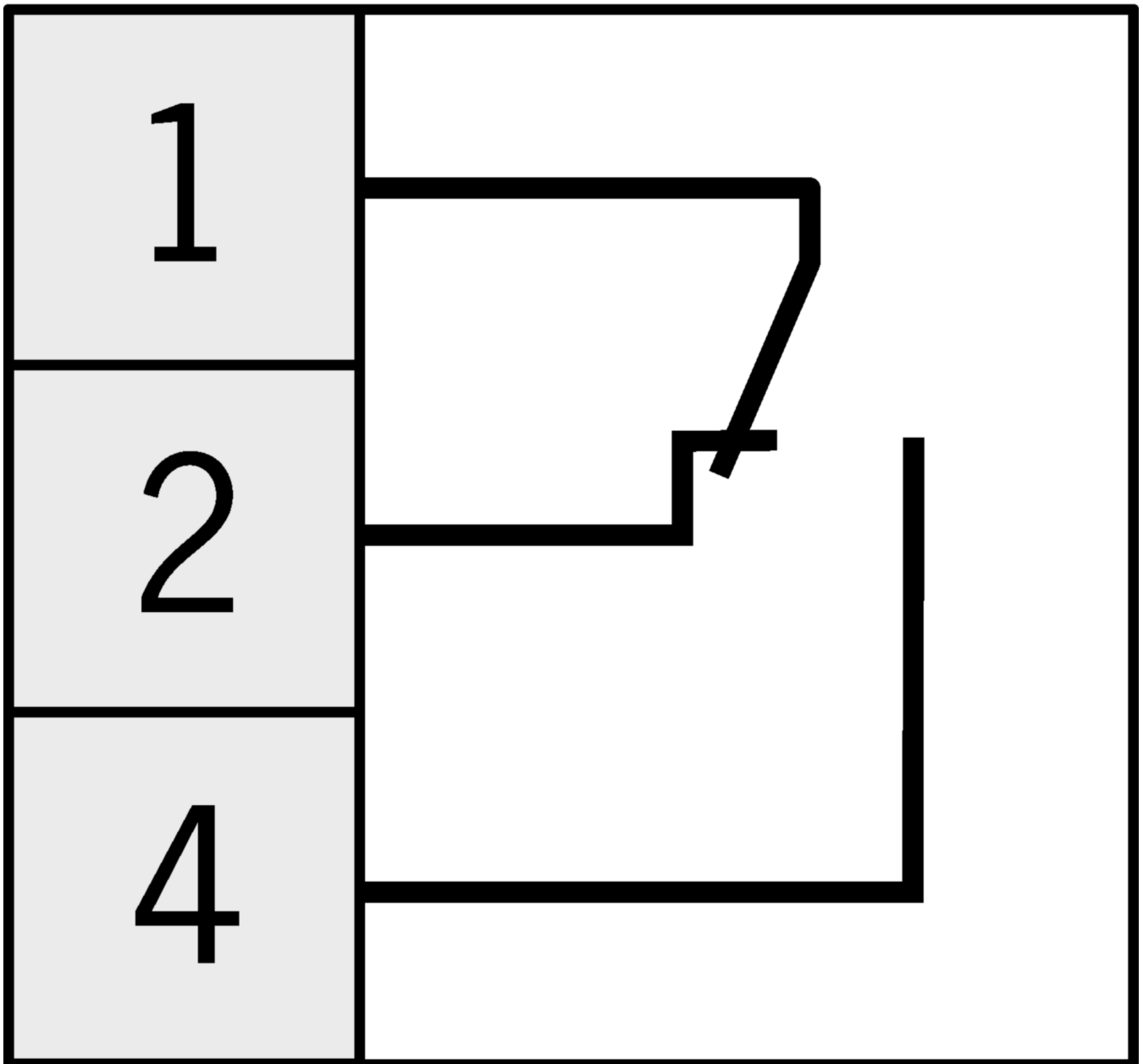

## Technical data

### Approvals



### Electrical connection values

Fuse	max. 6 A gG	
Connection cross section	0.14 ... 1.0 mm <sup>2</sup>	
Rated insulation voltage U <sub>i</sub>	250 V	
Rated impulse voltage U <sub>imp</sub>	2.5 kV	
Utilization category		
	DC-13	2 A 24 V
	AC-15	2 A 230 V
Switching current		
	min. at DC 24V	min. 10 mA
thermal rated current I <sub>th</sub>	6 A	

### Mechanical values and environment

Anfahrsgeschwindigkeit	0.01 ... 20 m/min	
Connection type		
	3 x	M20 x 1.5
Number of switching elements	2	
Number of changeover contacts	2	
Tightening torque		
	Screw terminal	max. 0.2 Nm Hexagon socket AF 1.3 mm
Design	upright	
Actuating element	Chisel plunger (Operating point accuracy ± 0.02. The reproducible operating point accuracy refers to the axial travel of the plunger after the switching element ES 552 has been run-in with approx. 2,000 operating cycles.)	
Actuating force	min. 15 N	
Installation orientation	any	