

C-M08F03-02X025PV20,0-ES-077716 (Order no. 077716)

Connecting cable with plug connector M8, 3-pin, 20 m

- ▶ M8 female plug, 3-pin
- ▶ Straight plug connector
- ▶ PVC cable
- ▶ Cable length 20 m
- ▶ With flying lead

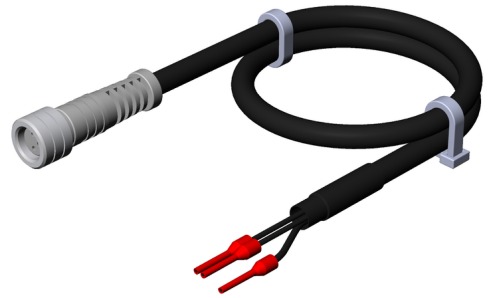

Dimensional drawings

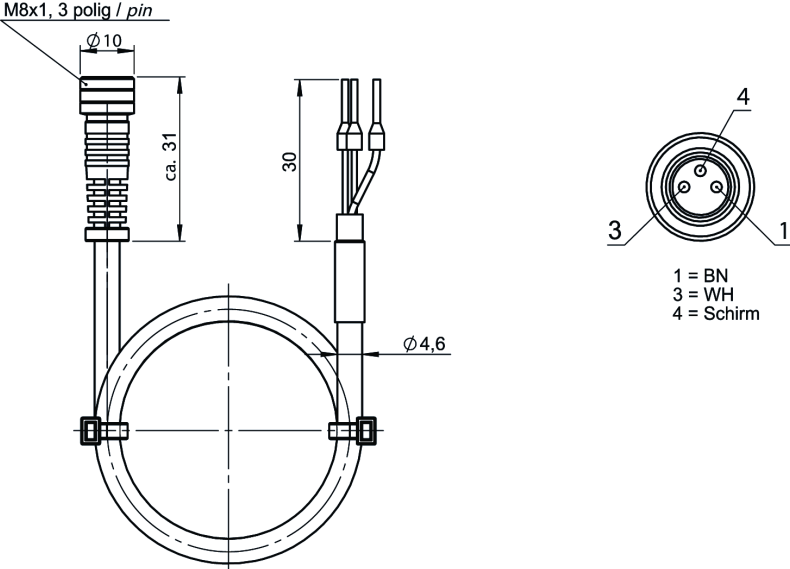

Technical data

Approvals



Electrical connection values

Rated voltage	DC	60 V
Rated impulse voltage U_{imp}		1.5 kV
Test voltage		0.5 kV
Cable shielding		Yes
specific inductance		0.65 mH/km
specific capacitance		120 nF/km
specific capacitance		160 nF/km
specific conductor resistance	at 20 °C	max. 79 Ω/km
Degree of contamination according to EN 60664-1		3

Mechanical values and environment

Conductor identification	Color code
Conductor cross-section	0.25 mm ²
Number of conductors	2
Tightening torque	0.4 Nm
Dynamic bending radius	10x cable diameter
Static bending radius	5x cable diameter
Fire behavior	self-extinguishing and flame retardant according to IEC 60332-1-2
Insulating material group	II
Storage temperature	-25 ... 80 °C
Cable type	straight