

MGB-L1-APA-AP4A1-S1-R-158117 (Order no. 158117)

Locking module MGB-L1-APA.. (guard locking by spring force) with 3 pushbuttons, emergency stop, RC18

- ▶ Guard locking with guard lock monitoring
- ▶ Emergency stop according to ISO 13850
- ▶ 3 pushbuttons (illuminated)
- ▶ With lens set, 6 pcs.
- ▶ With plug connector RC18
- ▶ Unicode

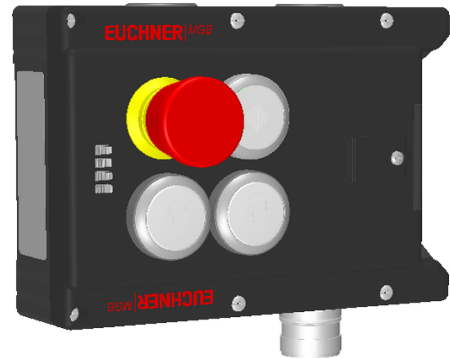

Guard locking type

MGB- The locking arm is held in the locked position by spring force and is unlocked by solenoid force
L1... (closed-circuit current principle, mechanically locked).

Door hinge

A mechanical door stop is permanently integrated into the evaluation module of the MGB. A marking on the stop makes adjustment easier.

LED indicator

The LED indicator indicates all important system and status information.

Monitoring outputs

OT Bolt tongue inserted into the evaluation module

OI Diagnostics; there is a fault

Emergency stop device

S1 2 positively driven contacts, emergency stop with turn-to-reset, not illuminated

Pushbuttons

S2 1 NO contact, illuminated

S3 1 NO contact, illuminated

S4 1 NO contact, illuminated

Lens set

The color of the pushbuttons can be selected using the color cover set included (5 colors). Item no.: 120344 (see Accessories)

Dimensional drawings

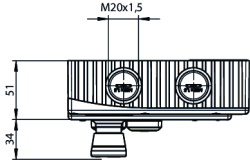
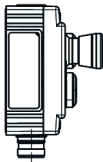
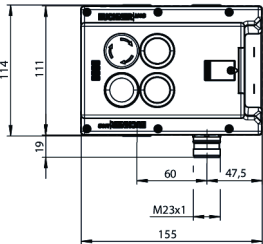
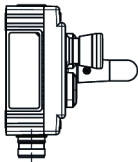
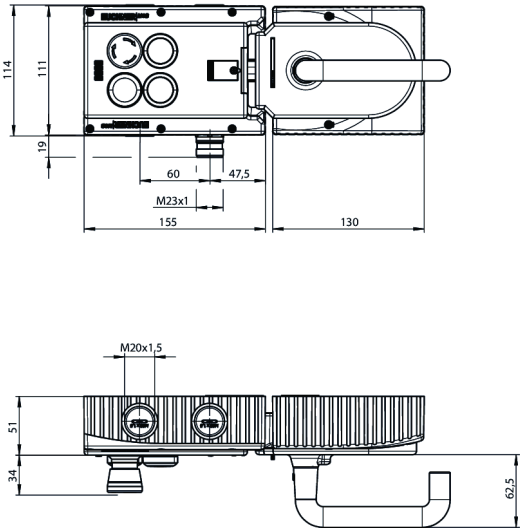
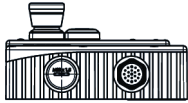
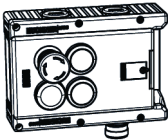
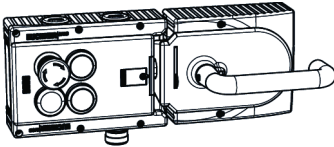
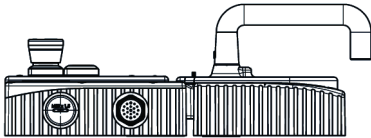

Dimensional drawings

