

C-M08F04-04X025PV02,0-ES-088812 (Order no. 088812)

Connecting cable with plug connector M8, 4-pin, 2 m

- ▶ M8 female plug, 4-pin
- ▶ Straight plug connector
- ▶ PVC cable
- ▶ Cable length 2 m
- ▶ With flying lead



Dimensional drawings

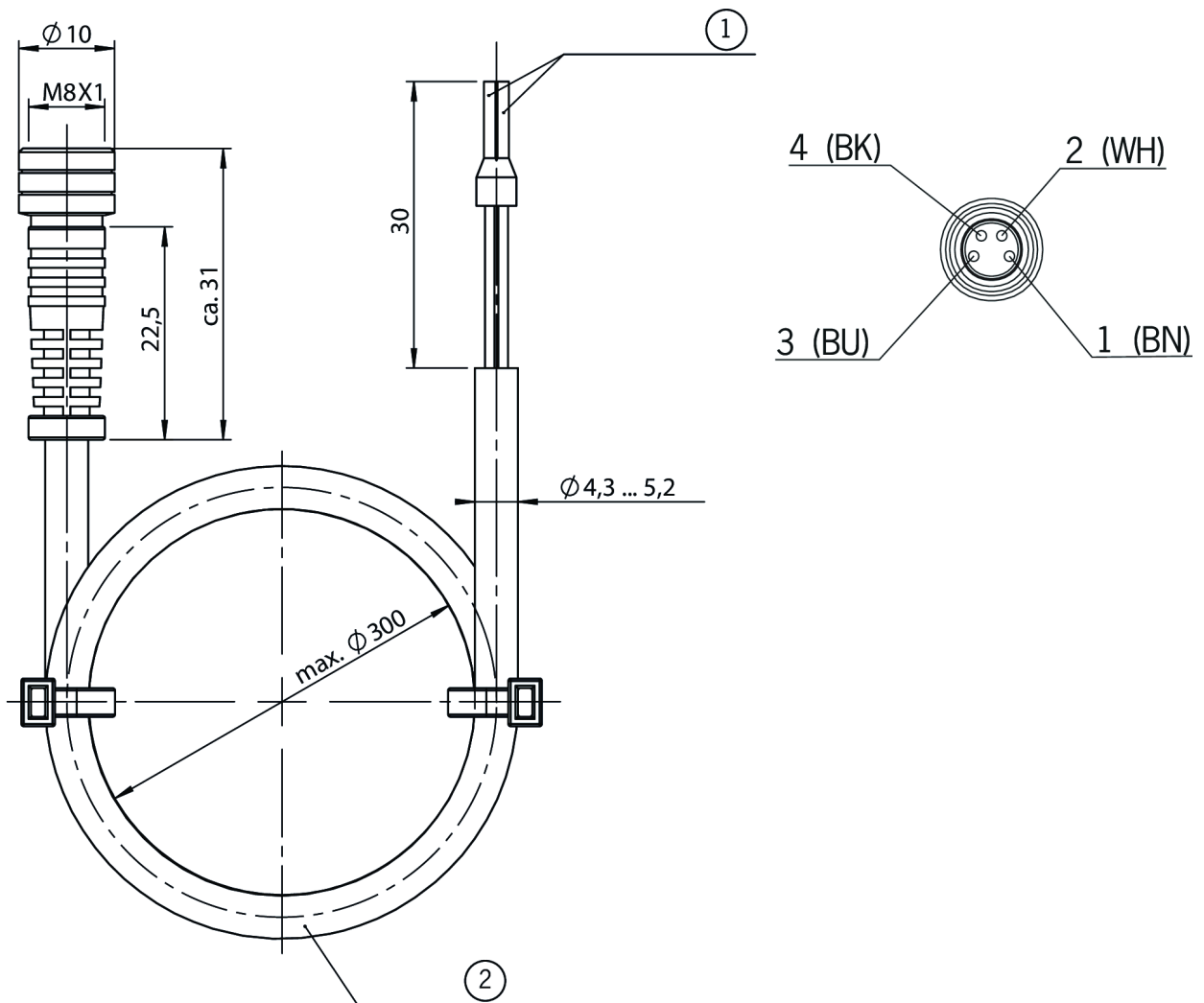

1 Cable end sleeves with insulating collar, color code according to DIN 46228

2 PVC cable LiYY-4 x 0.25²

Technical data

Approvals



Electrical connection values

Connection 1	
Rated voltage	36 V

Mechanical values and environment

Conductor identification	Color code
Conductor cross-section	0.25 mm ²
Number of conductors	4
Tightening torque	0.3 Nm
Dynamic bending radius	10 x cable diameter
Static bending radius	5 x cable diameter
Storage temperature	-30 ... 80 °C
Cable type	straight
Cable diameter	approx. 4.3 mm
Cable length	2 m
Sheath color	black
Drag chain suitability	No
Cable ambient temperature (dynamic)	-5 ... 70 °C
Cable ambient temperature (static)	-30 ... 80 °C
Material	Sheath PVC

Connection 2

Conductor end	Cable end sleeve
Connection type	flying lead

Connection 1

Connection type Plug connector M8x1

Connection type Female plug

Cable outlet straight

Number of pins 4

Degree of protection IP67
(in the inserted state)

Plug lock Screw connection

Material

Plug housing TPU