

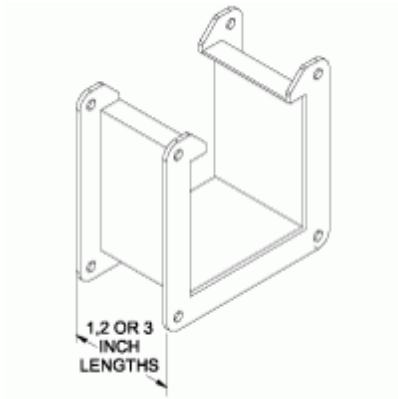

Quality Products. Service Excellence.

Nipple 1485 M Series



- Lay-in nipples come with a special sealing plate which cannot be used adjacent to swivel nipples (use 1487 Series nipples)

1" Nipple Part No.	2" Nipple Part No.	3" Nipple Part No.	Size
1485BM1	1485BM2	1485BM3	2.5 x 2.5
1485CM1	1485CM2	1485CM3	4 x 4
1485DM1	1485DM2	1485DM3	6 x 6

One flat sealing plate included



Data subject to change without notice

© 2021. Hammond Manufacturing Ltd. All rights reserved.