

WALL PLATES & SPECIALTIES



SWP26LA

Screwless Polycarbonate Wall Plates

- A. Molded of rugged .065" thick polycarbonate.**
- B. Seamless, sleek, super smooth construction** provides no dirt-catching channel around plate's perimeter.
- C. Two-piece plastic subplate** bridges recessed boxes and uneven sheet rock. Fixes floating installations.
- D. Automatic alignment pins** ensure that devices are properly positioned so that wall plates fit perfectly.
- E. Oversized opening** to accommodate all NEMA 26 decorator-style openings.
- F. An extra 1/8" width and height than standard size wall plates** for more tolerance in covering ragged sheet rock openings.

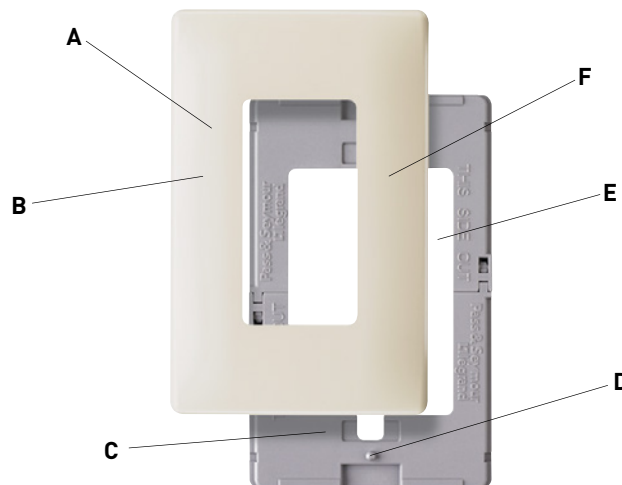

SWP26LA

WALL PLATES

Specifications



**Thermoset
SP Series**



**Nylon
TP Series**



**Screwless
Polycarbonate
SWP Series**



**302/304
Stainless
Steel**



**Polished
Brass**

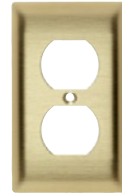

**Brushed
Brass**



Aluminum

Application

Legrand's broad line of Pass & Seymour® Standard Size Plastic and Metal Wall Plates features the most complete range of types, sizes, colors, and finishes available. Choose from more than 1,900 standard plates in non-combustible thermoset plastic material, self-extinguishing nylon material, screwless polycarbonate material, or attractively finished metal, for residential, commercial, institutional, and industrial applications. All plastic wall plates color match to Pass & Seymour devices.

Thermoset Plastic Wall Plates

- Molded of non-combustible mar-proof material.
- Available in "SP" series in Standard, Junior-Jumbo, and Jumbo sizes.
- Seven standard colors available – Ivory, White, Brown, Gray, Black, Red, and Light Almond.
- Individually wrapped with color-matching screws.
- Resistant to discoloration, grease, oil, solvent and moisture.
- Nominal thickness, .070"

TradeMaster® Thermoplastic Wall Plates

- Molded of rugged, practically indestructible self-extinguishing nylon. ("TP" series only)
- Available in "TP" series, extra 3/16" width and height than Standard size plates; and "TPJ" series, extra 3/16" width and height than Junior-Jumbo size plates.
- Available in Ivory, White, Brown, Gray, Black, Blue, Orange, Red, and Light Almond.
- Preferred for hospital, industrial, institutional, and other high-abuse applications.
- Nominal thickness, .070"

Screwless Polycarbonate Wall Plates

- Molded of .065" thick polycarbonate, matte finish.
- 2-piece plastic subplate made of polycarbonate.
- Extra 1/8" width and height than Standard size plates.
- Available in Ivory, White, Brown, Gray, Black, and Light Almond; and three metallic finishes.

Metal Wall Plates

- Constructed of corrosion-resistant stainless steel, brass, aluminum, chrome, brushed bronze or galvanized steel.
- Standard, Jumbo, and Tandem size plates available, as well as special Panel size plates up to 5-gangs high and 10-gangs wide.
- Packaged in protective film, with finish-matching screws.
- Variety of special plated finishes. Paintable to match plastic plates.
- Can be silk-screened or engraved, and custom punched with over 300 opening styles.

Materials

- Type 302/304 Stainless Steel, non-magnetic, .032" nominal thickness, brushed finish. This alloy contains 18% chromium and 8% nickel for superior resistance to corrosion. Recommended for use in food processing plants, dairies, chemical plants, and other industrial, institutional, and commercial applications where corrosive atmospheres exist.
- Type 430 Stainless Steel, magnetic, .032" nominal thickness, brushed finish. Less corrosion-resistant than Type 302/304, but ideal for general service in high abuse applications in industrial plants, commercial, and institutional buildings.
- Chrome, Brushed and Polished Brass, .040" thick. 70% copper, 30% zinc alloy gives warm, appealing finish to modern decor as well as retrofit applications. Lacquered to prevent corrosion.
- Aluminum, .040" thick. Lustrous satin finish. Lacquered to prevent corrosion.
- Galvanized Steel. Used only for Handy Box Plates.
- Brushed Bronze, .040" thick. 90% copper, 10% zinc. Lacquered to prevent corrosion.

WALL PLATES

Dimensions

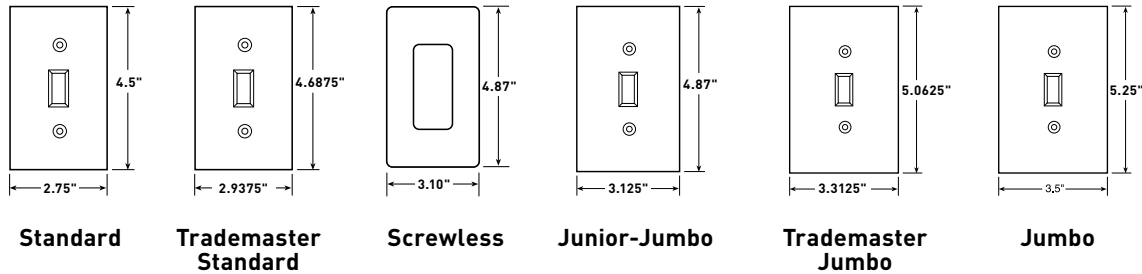

Standard Size Wall Plates

- Standard size wall plates for all applications.
- Best fit for surface mount boxes.
- Available in plastic and metal only.

Dimensions

1 gang	2.75" x 4.5"
2 gang	4.56" x 4.5"
3 gang	6.375" x 4.5"
4 gang	8.125" x 4.5"
5 gang	10" x 4.5"
6 gang	11.812" x 4.5"
7 gang	13.62" x 4.5"
8 gang	15.44" x 4.5"

TradeMaster® Wall Plates

- Extra 3/16" width and height than Standard size wall plates.
- Provide better sheet rock coverage with standard size appearance.
- Available in unbreakable nylon 6 construction only.
- Screws pre-installed in the duplex, toggle and decorator single gang plates.

Dimensions

1 gang	2.9375" x 4.6875"
2 gang	4.75" x 4.6875"
3 gang	6.563" x 4.6875"
4 gang	8.375" x 4.6875"
5 gang	10.188" x 4.6875"
6 gang	12" x 4.6875"

Screwless Polycarbonate Wall Plates

- Available in decorator openings.
- Extra 1/8" width and height than Standard size wall plates.
- Provide better sheet rock coverage with standard size appearance.
- Molded of .065" thick polycarbonate.
- 2-piece plastic subplate made of polycarbonate.
- Available in 3 metallic finishes and 6 standard colors.

Wall Plate Dimensions

1 gang	3.10" x 4.87"
2 gang	4.912" x 4.87"
3 gang	6.724" x 4.87"
4 gang	8.536" x 4.87"

Subplate Dimensions

1 gang	2.85" x 4.62"
2 gang	4.662" x 4.62"
3 gang	6.474" x 4.62"
4 gang	8.286" x 4.62"

Junior-Jumbo Wall Plates

- Extra 3/8" width and height than Standard size wall plates.
- Additional coverage for sheet rock gaps.
- Available in plastic and metal only.

Dimensions

1 gang	3.125" x 4.87"
2 gang	4.93" x 4.87"
3 gang	6.75" x 4.87"
4 gang	8.56" x 4.87"

TradeMaster® Jumbo Wall Plates

- Extra 3/16" width and height than Junior-Jumbo size wall plates.
- Provide additional coverage for sheet rock gaps, matching the appearance of the TradeMaster Plates.
- Available in unbreakable nylon 6 construction only.
- Screws pre-installed in the duplex, toggle, and decorator single gang plates.

Dimensions

1 gang	3.3125" x 5.0625"
2 gang	5.125" x 5.0625"
3 gang	6.9375" x 5.0625"
4 gang	8.75" x 5.0625"

Jumbo Wall Plates

- Extra 3/4" width and height than Standard size wall plates.
- Largest size wall plates to cover larger wall damage.
- Available in plastic and metal only.

Dimensions

1 gang	3.5" x 5.25"
2 gang	5.31" x 5.25"
3 gang	7.12" x 5.25"
4 gang	8.93" x 5.25"

WALL PLATES

Dimensions

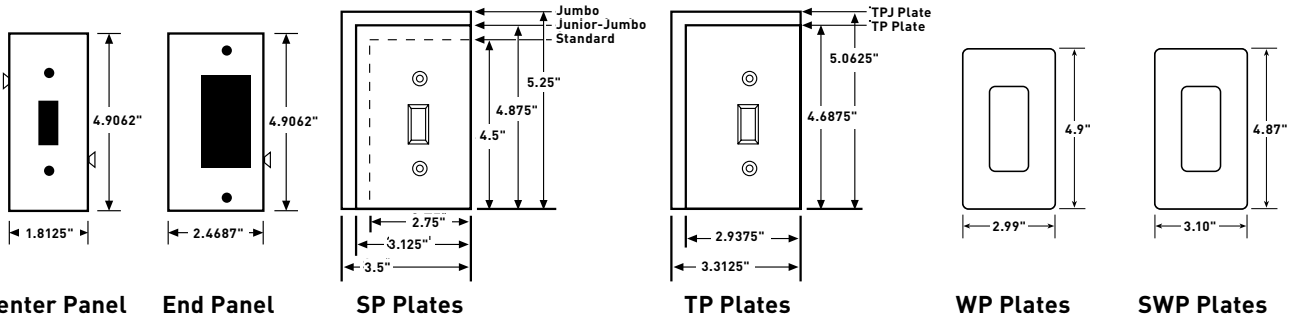

Center Panel End Panel SP Plates TP Plates WP Plates SWP Plates

Sectional Wall Plates

End and center panels with each of five most-used configurations make it possible to improvise custom wall plates on the job. Panels lock securely together on installation. Blank sections furnished with mounting strap.

Wall Plate Mountings

Illustrated are the five standard methods of plate mounting. There are many other non-standard methods which depend upon the special device used. Exact mounting hole specifications for every device appear in the Selector Guide.

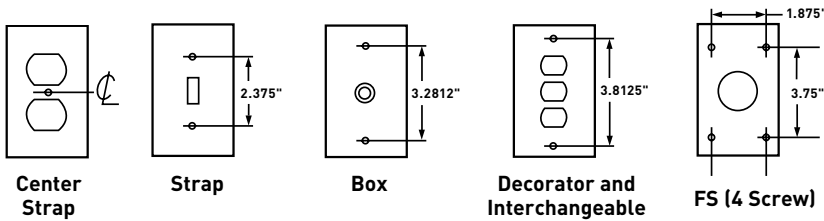





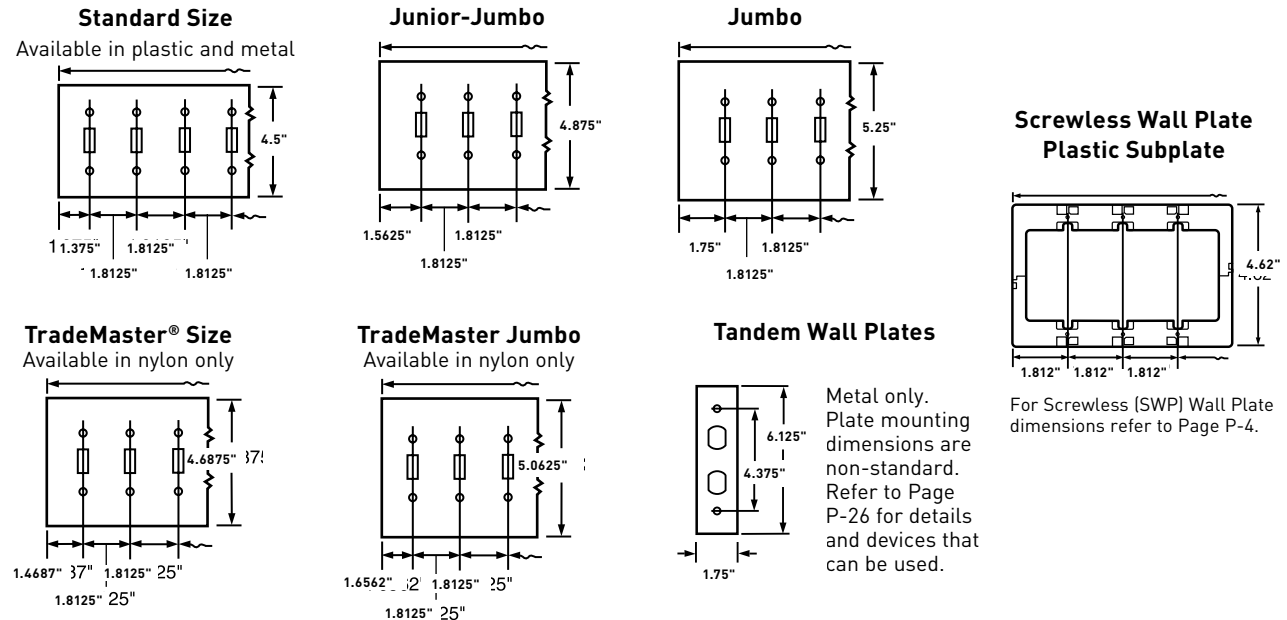

Center Strap Strap Box Decorator and Interchangeable FS (4 Screw)

Wall Plate Sizes

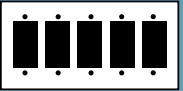

WALL PLATES

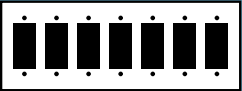
Decorator Openings Standard Size Plastic & Metal

DESCRIPTION	COLOR	NYLON	THERMOSET	METAL	
		TRADEMASTER® PLATES	SMOOTH	MATERIAL	SMOOTH
DECORATOR OPENINGS					
Two Gang 	Ivory	TP262I	SP262I	Aluminum Brass Polished Brass 430S/S 302/304 S/S	SA262 SB262 SB262PB SL262 SS262
	White	TP262W	SP262W		
	Brown	TP262	SP262		
	Gray	TP262GRY	SP262GRY		
	Black	TP262BK	SP262BK		
	Red	TP262RED			
	Light Almond	TP262LA	SP262LA		
	Blue	TP262BL			
	Orange	TP262OR			
Three Gang 	Ivory	TP263I	SP263I	Brass Polished Brass 302/304 S/S	SB263 SB263PB SS263
	White	TP263W	SP263W		
	Brown	TP263			
	Gray	TP263GRY	SP263GRY		
	Black	TP263BK	SP263BK		
	Red	TP263RED			
	Light Almond	TP263LA	SP263LA		
Four Gang 	Ivory	TP264I	SP264I	Brass Polished Brass 302/304 S/S	SB264 SB264PB SS264
	White	TP264W	SP264W		
	Brown	TP264	SP264		
	Gray	TP264GRY	SP264GRY		
	Black	TP264BK	SP264BK		
	Red	TP264RED			
	Light Almond	TP264LA	SP264LA		
Five Gang 	Ivory	TP265I	SP265I	302/304 S/S	SS265
	White	TP265W	SP265W		
	Brown	TP265			
	Gray	TP265GRY	SP265GRY		
	Black	TP265BK	SP265BK		
	Red	TP265RED	SP265RED		
	Light Almond	TP265LA	SP265LA		
Six Gang 	Ivory	TP266I	SP266I	302/304 S/S	SS266
	White	TP266W	SP266W		
	Brown	TP266	SP266		
	Gray	TP266GRY	SP266GRY		
	Black	TP266BK	SP266BK		
	Light Almond	TP266LA	SP266LA		
Seven Gang 				302/304 S/S	SS267
				302/304 S/S Painted Ivory	SS267I
				302/304 S/S Painted White	SS267W
Eight Gang 				302/304 S/S	SS268
				302/304 S/S Painted Ivory	SS268I
				302/304 S/S Painted White	SS268W

WALL PLATES

Custom Metal Wall Plates Special Configurations

Chart B: Paint Finish Selection

These charts are for Custom Metal Wall Plates ONLY.
For Devices & Wall Plates Color Selection Charts, see Pages A-29, B-87 and P-58.

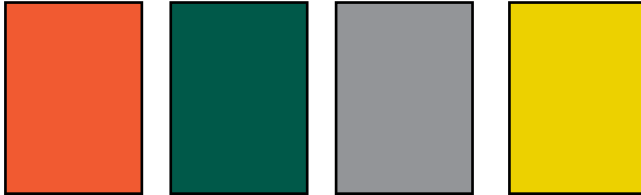

PAINT COLOR	Orange	Green	Gray	Yellow
PAINT SUFFIX	ORG	GRN	GRY	YFI

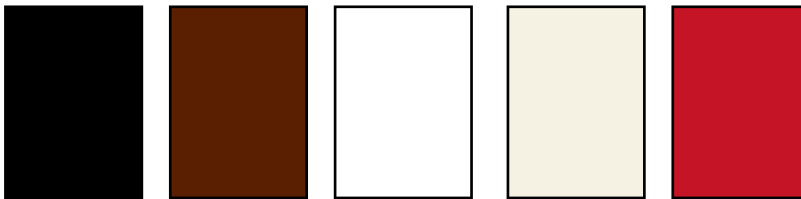

PAINT COLOR	Glossy Black	Brown	White	Primer	Red
PAINT SUFFIX	GBK	BR0	WHT	PRI	RED

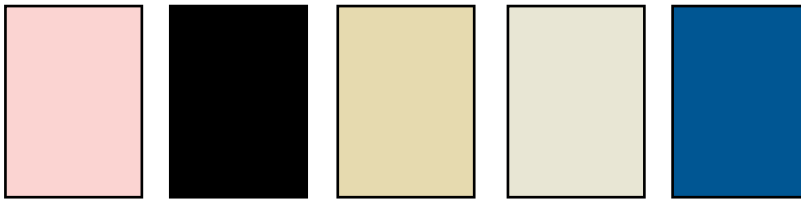

PAINT COLOR	Pink	Flat Black	Ivory	Light Almond	Blue
PAINT SUFFIX	PNK	FBK	IVY	LTA	MBL

Only available on Stainless Steel and Aluminum Plate Material. Colors may vary slightly.
All Paint Finishes are gloss, except primer and flat black.

Chart C: Metal Finish Selection



METAL FINISH	Polished Brass US #3	Bright Chromium US #26	Brushed Copper	Brushed Bronze US #10	Brushed Brass Standard Finish
FINISH SUFFIX	PB*	CH	BC	BZ	BB

*Order with Brass Plate Material Prefix Only.
For additional colors consult factory.