

# Wallplates

Our extensive line of wallplates is designed and manufactured to perform in a wide range of applications; no matter what you need, you'll find the desired material, configuration, size and color. Their heavy-duty construction provides outstanding performance throughout a home. Available in one- through six-gang configurations.



## Wallplate families

Standard size wallplates

**C-10**

Mid-size wallplates

**C-17**

Oversize wallplates

**C-24**

Wallplate accessories

**C-25**

## Wallplate colors

Almond	Black
Brown	Gray
Ivory	Lt. Almond
White	Brushed Bronze
Blue	Solid Brass
Red	Stainless Steel

- Mid-size screwless wallplates deliver the ultimate in designer looks with a screwless finish; they are fast and easy to install, virtually unbreakable and easy to clean
- Mid-size & oversize wallplates are designed for use in applications where additional wall coverage is needed
- Extra depth wallplates are available for use with old work outlet boxes for a flush fit to the wall
- Available wallplate materials include virtually unbreakable nylon & polycarbonate thermoplastics, 302/304 corrosion resistant stainless steel, brass, and thermoset
- Nylon & polycarbonate wallplates feature screw-catch, a timesaving feature that holds mounting screws captive to simplify installation
- Our wallplates are manufactured according to the performance & dimensional requirements of Federal Specification WP-455, NEMA Standard WD-1, UL Standard 514 and the NEC®

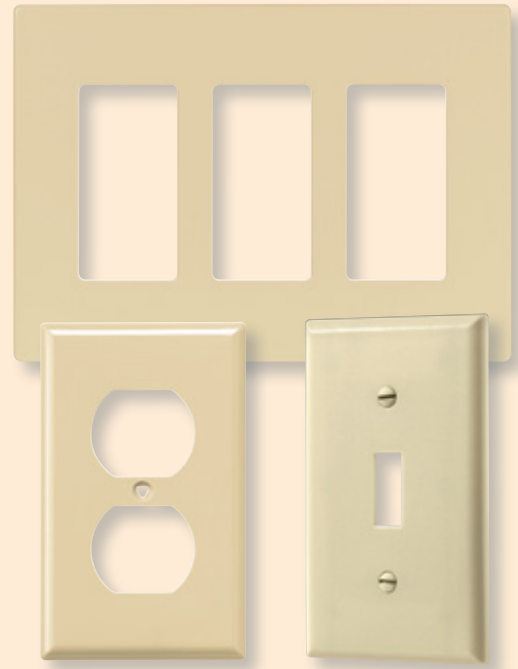

## Specific wallplate solutions for today's needs



### Aesthetic upgrade

Our screwless wallplates come in 3 different openings for upgrading the look of toggle switches, GFCIs, rotary dimmers and duplex receptacles without having to change out devices!

See pages C-17 to C-19

Shown:  
PJS1



### Corrosion resistance

Brass and stainless steel wallplates offer durable, elegant corrosion resistance making them ideal for high-moisture locations like kitchens, baths, garages and basements.

See pages C-10 to C-25

Shown:  
93101

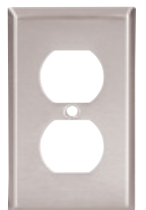

### Impact resistance

Thermoplastic polycarbonate and nylon wallplates are virtually unbreakable, warp resistant, abrasion resistant and soil resistant, making them ideal for high-traffic areas.

See pages C-10 to C-26

Shown:  
PJ26





### Thermoplastic nylon or polycarbonate wallplates

#### Design features

- Rugged construction reduces installation cost due to less plate breakage and resists bowing to provide a smooth, flat installation
- Exclusive timesaving Screw-catch feature holds mounting screws captive and simplifies installation
- High gloss finish is soil resistant
- Polycarbonate wallplates are virtually unbreakable with high structural rigidity, long-term form retention, plus superior impact and abrasion resistance

- Nylon wallplates have a flush-fitting, warp resistant design
- Matching mounting screws provide

#### Testing & code compliance

- cULus listed to UL514C, file no. E33216, certified to CSA C22.2, no. 42.1

#### Material characteristics

- Flammability: meets UL94 requirements; 5V rated
- Temperature rating: -40°C to 70°C (-40°F to 158°F)



### Thermoset wallplates

#### Design features

- Extensive line of non-flammable thermoset plates provides flush-fitting, warp resistant performance

#### Material characteristics

- Flammability: Meets UL94 requirements; 5V rated
- Temperature rating: -40°C to 65°C (-40°F to 149°F)

#### Testing & code compliance

- cULus listed to UL514C, file no. E33216, certified to CSA C22.2, no. 42.1



### 302/304 Stainless steel wallplates

#### Design features

- Superior non-corrosive and non-magnetic properties for applications needing protection from those elements
- Stainless steel alloy contains 18% chromium and 8% nickel for corrosion resistance
- Stamped from 0.032" (0.81mm) thick material
- Horizontally satin-brushed surface finish resists finger prints
- All plates are coated with clear, removable PVC to safeguard the surface during handling and installation

- Matching stainless steel mounting screws provided

#### Testing & code compliance

- Listed to UL514D, file no. E92122, certified to CSA C22.2, no.42.1

#### Material characteristics

- Temperature rating: -40°C to 70°C (-40°F to 158°F)



### Brass wallplates

#### Design features

- Line of handsomely crafted, elegant solid brass designs in 11 popular NEMA standard size configurations
- Strong, corrosion resistant and coated with transparent lacquer to resist premature oxidation
- Horizontally satin-brushed surface finish resists fingerprints
- Matching brass-plated steel screws resist damage during installation

- All plates are coated with clear, removable PVC to safeguard the surface during handling and installation
- Solid brass material is a 70/30 alloy (#26C), .040" (1.02mm) thick

#### Testing & code compliance

- Listed to UL514D, file no. E92003

#### Material characteristics

- Temperature rating: -40°C to 70°C (-40°F to 158°F)

Compliances, specifications and availability are subject to change without notice.

## Toggle

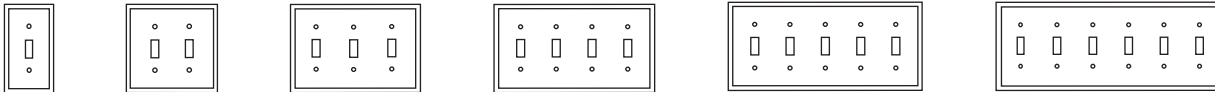

Gang	Standard size				Mid-size				Oversize	
	Thermoset	Nylon	Stainless steel	Brass	Thermoset	Polycarbonate	Screwless	Stainless steel	Thermoset	Stainless steel
1-Gang	2134__	5134__	93071	94071	2034__	PJ1__	PJS1__	93971	2144__	93871
2-Gang	2139__	5139__	93072	94072	2039__	PJ2__	PJS2__	93972	2149__	93872
3-Gang	2141__	5141__	93073	94073	2041__	PJ3__	PJS3__	93973	2741__	93873
4-Gang	2154__	5154__	93074	—	2054__	PJ4__	PJS4__	—	—	93874
5-Gang	2155__	—	93075	—	—	PJ5__	—	—	—	—
6-Gang	2156__	—	93076	—	—	PJ6__	—	—	—	—

## Decorator/GFCI

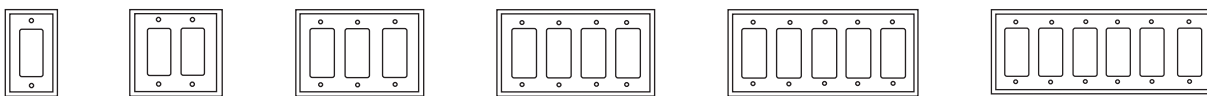

Gang	Standard size				Mid-size				Oversize	
	Thermoset	Nylon	Stainless steel	Brass	Thermoset	Polycarbonate	Screwless	Stainless steel	Thermoset	Stainless steel
1-Gang	2151__	5151__	93401	94401	2051__	PJ26__	PJS26__	93934	2751__	93834
2-Gang	2152__	5152__	93402	94402	2052__	PJ262__	PJS262__	93935	—	—
3-Gang	2163__	—	93403	—	2063__	PJ263__	PJS263__	93936	—	—
4-Gang	2164__	—	93404	—	2064__	PJ264__	PJS264__	—	—	—
5-Gang	2165__	—	93405	—	—	PJ265__	PJS265__	—	—	—
6-Gang	2166__	—	93406	—	—	PJ266__	PJS266__	—	—	—

## Duplex receptacle

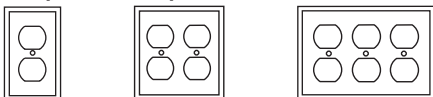

Gang	Standard size				Mid-size				Oversize	
	Thermoset	Nylon	Stainless steel	Brass	Thermoset	Polycarbonate	Screwless	Stainless steel	Thermoset	Stainless steel
1-Gang	2132__	5132__	93101	94101	2032__	PJ8__	PJS8__	93901	2142__	93801
2-Gang	2150__	5150__	93102	94102	2050__	PJ82__	—	93902	2750__	93802
3-Gang	—	—	93103	—	—	—	—	—	—	—

## Blank

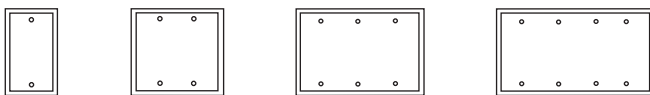

Gang	Standard size				Mid-size				Oversize	
	Thermoset	Nylon	Stainless steel	Brass	Thermoset	Polycarbonate	Screwless	Stainless steel	Thermoset	Stainless steel
1-Gang	2129__	5129__	93151	94151	2029__	PJ13__	—	93951	2729__	93851
2-Gang	2137__	5137__	93152	—	2037__	PJ23__	—	—	—	93852
3-Gang	—	—	93153	—	—	—	—	—	—	—
4-Gang	—	—	93154	—	—	—	—	—	—	—
1-strap mt.	—	—	—	—	—	PJ14__	—	—	—	—

Compliances, specifications and availability are subject to change without notice.

## Wallplate sizes

Gang	Description	Height	Width	First gang to edge	Gang to gang
1-Gang	Standard	4.50" (114.3mm)	2.75" (34.9mm)	1.37" (34.9mm)	—
	Mid-size	4.87" (123.8mm)	3.13" (79.4mm)	1.56" (39.7mm)	—
	Oversize	5.25" (133.4mm)	3.5" (88.9mm)	1.75" (44.4mm)	—
2-Gang	Standard	4.50" (114.3mm)	4.56" (115.9mm)	1.37" (34.9mm)	1.81" (46.0mm)
	Mid-size	4.87" (123.8mm)	4.94" (125.4mm)	1.56" (39.7mm)	1.81" (46.0mm)
	Oversize	5.25" (133.4mm)	5.31" (134.9mm)	1.75" (44.4mm)	1.81" (46.0mm)
3-Gang	Standard	4.50" (114.3mm)	6.37" (161.9mm)	1.37" (34.9mm)	1.81" (46.0mm)
	Mid-size	4.87" (123.8mm)	6.75" (171.4mm)	1.56" (39.7mm)	1.81" (46.0mm)
	Oversize	5.25" (133.4mm)	7.17" (182.2mm)	1.75" (44.4mm)	1.81" (46.0mm)
4-Gang	Standard	4.50" (114.3mm)	8.19" (207.9mm)	1.37" (34.9mm)	1.81" (46.0mm)
	Mid-size	4.87" (123.8mm)	8.56" (217.5mm)	1.56" (39.7mm)	1.81" (46.0mm)
	Oversize	5.25" (133.4mm)	8.94" (227.0mm)	1.75" (44.4mm)	1.81" (46.0mm)
5-Gang	Standard	4.50" (114.3mm)	10.00" (254.0mm)	1.37" (34.9mm)	1.81" (46.0mm)
	Mid-size	4.87" (123.8mm)	10.37" (263.5mm)	1.56" (39.7mm)	1.81" (46.0mm)
6-Gang	Standard	4.50" (114.3mm)	11.81" (300.0mm)	1.37" (34.9mm)	1.81" (46.0mm)
	Mid-size	4.87" (123.8mm)	12.18" (309.5mm)	1.56" (39.7mm)	1.81" (46.0mm)

**Standard**

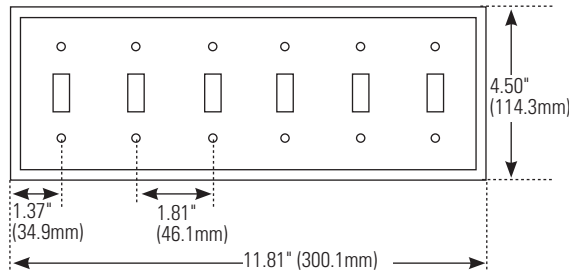

**Mid-size**

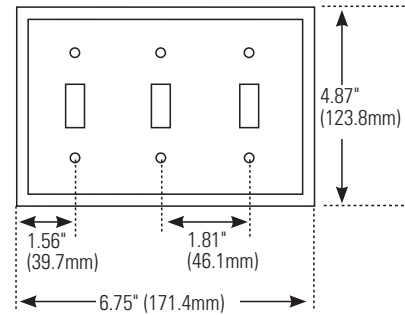

**Oversize Mid-size Standard**

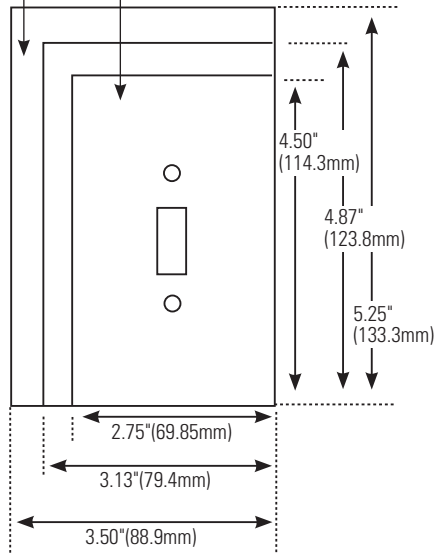

**Oversize**

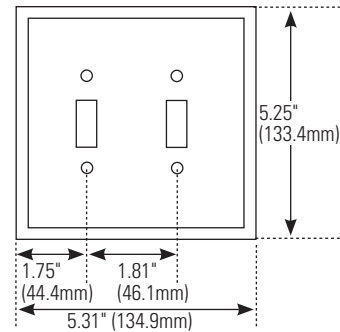

Compliances, specifications and availability are subject to change without notice.

### Mid-size decorator wallplates

#### Product description

1-Gang, 2-Gang, 3-Gang,  
4-Gang, 5-Gang, 6-Gang

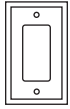

1-Gang

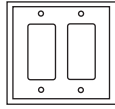

2-Gang

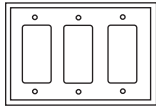

3-Gang

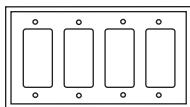

4-Gang

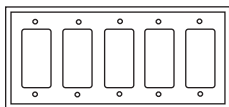

5-Gang

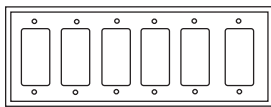

6-Gang

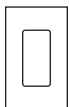

1-Gang

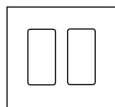

2-Gang

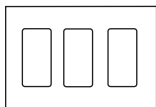

3-Gang

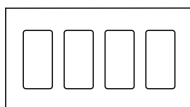

4-Gang

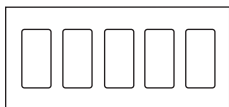

5-Gang

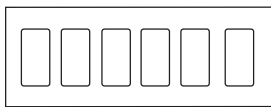

6-Gang

#### Decorator

Description	Material	Color suffix	Catalog no.		
1-Gang	Polycarbonate	A, B, BK, BL, GY, LA, RD, V, W	□ PJ26__		
	Thermoset	A, B, LA, V, W	□ 2051__		
	302/304 Stainless steel	—	□ 93934		
2-Gang	Polycarbonate	A, B, BK, GY, LA, RD, V, W	□ PJ262__		
	Thermoset	A, LA, V, W	□ 2052__		
	302/304 Stainless steel	—	□ 93935		
3-Gang	Polycarbonate	A, B, BK, GY, LA, V, W	□ PJ263__		
	Thermoset	A, LA, V, W	□ 2063__		
	302/304 Stainless steel	—	□ 93936		
4-Gang	Polycarbonate	A, B, BK, GY, LA, V, W	□ PJ264__		
	Thermoset	A, LA, V, W	□ 2064__		
5-Gang	Polycarbonate	A, B, BK, GY, LA, V, W	□ PJ265__		
6-Gang	Polycarbonate	A, B, BK, GY, LA, V, W	□ PJ266__		

### Mid-size decorator screwless wallplates

#### Product description

1-Gang, 2-Gang, 3-Gang,  
4-Gang, 5-Gang, 6-Gang

#### Screwless Decorator

Description	Material	Color suffix	Catalog no.	
1-Gang	Polycarbonate	A, B, BB, BK, GY, LA, V, W	□ PJS26__	
2-Gang	Polycarbonate	A, B, BB, BK, LA, V, W	□ PJS262__	
3-Gang	Polycarbonate	A, BB, BK, LA, V, W	□ PJS263__	
4-Gang	Polycarbonate	A, BK, LA, V, W	□ PJS264__	
5-Gang	Polycarbonate	A, BK, LA, V, W	□ PJS265__	
6-Gang	Polycarbonate	A, BK, LA, V, W	□ PJS266__	

#### Color ordering information:

For ordering devices, include Catalog no. followed by the Color suffix: A (Almond), B (Brown), BK (Black), GY (Gray), LA (Light Almond), RD (Red), V (Ivory), W (White), BB (Brushed Bronze), Stainless Steel

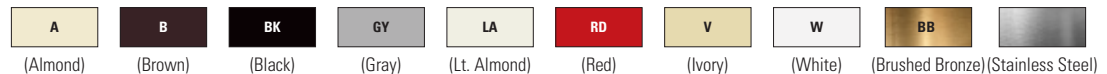

**Certification information:** 2000 and PJ series wallplates are cULus certified; 93000 series wallplates are UL and CSA certified

**Dimensional information:** C-5, C-6 **Specification information:** Please visit [www.eaton.com/wiringdevices](http://www.eaton.com/wiringdevices)

**Compliances, specifications and availability are subject to change without notice.**

Indicates NAFTA compliant - Page G-21

RoHS compliant - Page G-21