

CS4 Industrial Control Relays

Control &
Timing Relays
CS4

The miniature relay system with big advantages



The CS4C relay (for DC operation) with 4 pole auxiliary contact block

Despite increasing complexity, control systems and installations must become increasingly compact. And the CS4 Miniature Relay System packs maximum performance into minimum space.

Small but rugged

Sprecher + Schuh has subjected this relay series to monitored endurance tests that demonstrate their ruggedness. Under normal duty, CS4 contacts have a maximum electrical life of 3,500,000 operations, while the AC magnet system has a mechanical life of 10,000,000 operations.

The coil is designed for absolute undervoltage reliability. Undervoltages that do not cause the contactor to close can be withstood indefinitely without damage.

The body of the device is sturdy as well. The front housing, containing the phase partitions and screwdriver guides, is manufactured in one piece. Front and rear housing are then joint fitted together.

Superior Contact Reliability

The standard CS4 relay utilizes x-stamped contact technology that reliably switches signals as low as 17V @ 25mA. Some PLC and other electronic circuits operate at signals as low as 17V @ 5mA. These applications require the CS4-B relay with H-bridge, bifurcated contacts.

The bifurcated H-bridge design divides each movable contact into two sections at the tip of the spanner which provides a higher degree of reliability for low signal applications.

Mechanically linked contacts for safety

CS4 control relays are perfect for fail-safe control circuits. An interlock contact design, which maintains minimum 0.3mm clearance, prevents the NC contact from reclosing if the NO contact is welded when in operation. (This feature includes the base contact



poles only and does not extend to the front mounted auxiliary contacts.)

Accessories require no additional panel space

The entire CS4 system is logically engineered. Auxiliary contact blocks and timing elements are modular and snap-on without increasing the CS4's original width of 45mm. Also, due to its sideways switching movement, the basic relay has the same low profile whether an AC or DC operating magnet is used. This permits the use of enclosures with shallow mounting depths. Once the CS4 is installed, all auxiliary contact blocks can be snapped on or removed without changing any existing wiring.

Auxiliary components provide flexibility

CS4 auxiliary components allow you to convert the basic four pole relay up to an 8 pole relay.



Effortless installation

CS4 relays are DIN-rail mountable for instant installation and modification. Fittings are also included for base mounting. All terminals are clearly marked and shipped in the open position for installation with either manual or power screwdrivers. Using self-adhesive labels, paper tags or plastic clip-on tags.

The entire line is UL Listed and CSA Certified and offers finger and back of hand protection to the strictest international standards.

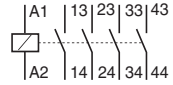
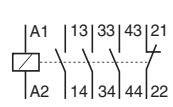
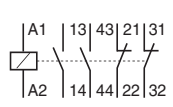

CS4 Complete Assemblies - 4 & 6 Pole ☉

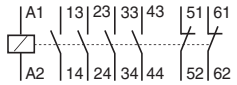
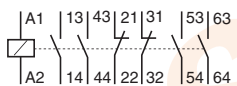
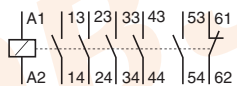
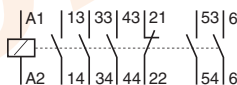
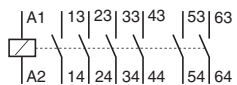
CS4 Relay	Contact Arrangement and Numbering	Contacts		AC Operation	DC Operation
		NO	NC	Catalog Number	Catalog Number
		4	0	CS4-40E-*	CS4C-40E-*
		3	1	CS4-31Z-*	CS4C-31Z-*
		2	2	CS4-22Z-*	CS4C-22Z-*
		4	2	CS4-42E-*	CS4C-42E-*
		4	2	CS4-42X-*	CS4C-42X-*
		5	1	CS4-51E-*	CS4C-51E-*
		5	1	CS4-51X-*	CS4C-51X-*
		6	0	CS4-60E-*	CS4C-60E-*

A.C. Coil Codes ☉

A.C. Coil Code	Voltage Range	
	50 Hz	60 Hz
24	24V	24V
48	48V	48V
120	110V	110V-120V
240	220V-230V	230V-240V
380	400V-415V	380V-400V

D.C. Coil Codes

D.C. Coil Code	Voltage
24D ☉	24VDC
48D	48VDC
110D	110VDC
220D	220VDC

Contact Ratings (Per UL508/NEMA A600 & Q600)

Standard	Circuit Voltage	Make (Amps/VA)	Break (Amps/VA)	Continuous Amps
A600	120AC	60A/7200VA	6A/720VA	10
	240AC	30A/7200VA	3A/720VA	
	480AC	15A/7200VA	1.5A/720VA	
	600AC	12A/7200VA	1.2A/720VA	
Q600	125DC	0.55A/69VA	0.55A/69VA	2.5
	250DC	0.27A/69VA	0.27A/69VA	
	301-600DC	0.1A/69VA	0.1A/69VA	

Ordering Instructions

- Specify catalog number
- Replace (*) with Coil Code

Refer to tables above

- The coil codes shown are for the most commonly stocked items. Contact your Sprecher + Schuh representative to determine if other voltages, i.e., 12, 208, 480 and 575V are on-hand or can be specially ordered in quantity.
- Integrated diode surge suppressor coils available. Order coil code **24DD** and add \$25 to list price. Ex: CS4C-40E-**24D** becomes CS4C-40E-**24DD**.
- CS4(B) relays are positively guided for 4 main poles. Restrictions apply when using auxiliary contacts.

CS4 Complete Assemblies - 8 Pole ③

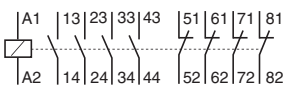
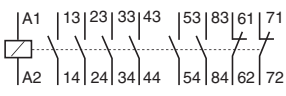
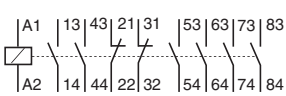
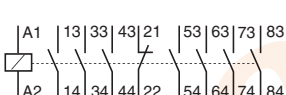
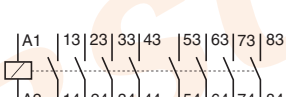
CS4 Relay	Contact Arrangement and Numbering	Contacts		AC Operation	DC Operation
		NO	NC	Catalog Number	Catalog Number
		4	4	CS4-44E-*	CS4C-44E-*
		6	2	CS4-62Z-*	CS4C-62Z-*
		6	2	CS4-62X-*	CS4C-62X-*
		7	1	CS4-71X-*	CS4C-71X-*
		8	0	CS4-80E-*	CS4C-80E-*

A.C. Coil Codes ①

A.C. Coil Code	Voltage Range	
	50 Hz	60 Hz
24	24V	24V
48	48V	48V
120	110V	110V-120V
240	220V-230V	230V-240V
380	400V-415V	380V-400V

D.C. Coil Codes

D.C. Coil Code	Voltage
24D ②	24VDC
48D	48VDC
110D	110VDC
220D	220VDC

Contact Ratings (Per UL508/NEMA A600 & Q600)

Standard	Circuit Voltage	Make (Amps/VA)	Break (Amps/VA)	Continuous Amps
A600	120AC	60A/7200VA	6A/720VA	10
	240AC	30A/7200VA	3A/720VA	
	480AC	15A/7200VA	1.5A/720VA	
	600AC	12A/7200VA	1.2A/720VA	
Q600	125DC	0.55A/69VA	0.55A/69VA	2.5
	250DC	0.27A/69VA	0.27A/69VA	
	301-600DC	0.1A/69VA	0.1A/69VA	

Ordering Instructions

- Specify catalog number
- Replace (*) with Coil Code

Refer to tables above

- ① The coil codes shown are for the most commonly stocked items. Contact your Sprecher + Schuh representative to determine if other voltages, i.e., 12, 208, 480 and 575V are on-hand or can be specially ordered in quantity.
- ② Integrated diode surge suppressor coils available. Order coil code **24DD** and add \$25 to list price. Ex: CS4C-44E-**24D** becomes CS4C-44E-**24DD**.
- ③ CS4(B) relays are positively guided for 4 main poles. Restrictions apply when using auxiliary contacts.

CS4-B Complete Assemblies - 4 Pole (Bifurcated contacts for low level signals) ①②

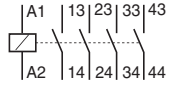
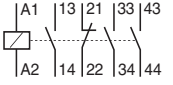
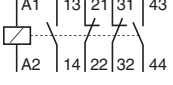
CS4 Relay	Contact Arrangement and Numbering	Contacts		AC Operation	DC Operation
		NO	NC	Catalog Number	Catalog Number
		4	0	CS4-B40E-24	CS4C-B40E-24D
		3	1	CS4-B31E-24	CS4C-B31E-24D
		2	2	CS4-B22E-24	CS4C-B22E-24D







Contact Ratings (Per UL508/NEMA A300 & Q300)

Standard	Circuit Voltage	Make (Amps/VA)	Break (Amps/VA)	Continuous Amps
A300	120AC	60A/7200VA	6A/720VA	10
	240AC	30A/7200VA	3A/720VA	
Q300	125DC	0.55A/69VA	0.55A/69VA	2.5
	250DC	0.27A/69VA	0.27A/69VA	



NOTE: Our standard CS4 relay utilizes x-stamped contact technology that reliably switches signals as low as 17V @ 25mA. Some PLC and other electronic circuits operate at signals as low as 17V @ 5mA. These applications require Sprecher + Schuh's CS4-B relay with H-bridge, bifurcated contacts.

① CS4-B low level signal relays are only available with 24V coils (AC or DC).
 ② CS4/(B) relays are positively guided for 4 main poles. Restrictions apply when using auxiliary contacts.

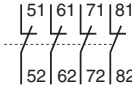
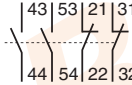
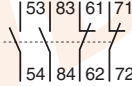
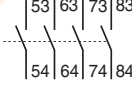
Auxiliary Contact Blocks (2 & 4 Pole) ①





Auxiliary Contact Blocks	Contact Arrangement	Catalog Number
		CA4-P02
		CS4-P02
		CA4-P11
		CS4-P11
		CS4-P20
		CS4-P04
		CA4-P22
		CS4-P22
		CS4-P40

Control Modules

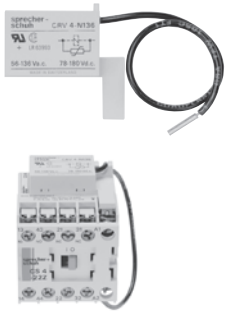

Module	Description	For use with...	Connection Diagrams	Function	Catalog Number
	Electronic Timing Module – ON-Delay The relay is energized at the end of the delay time.	CS4 all		110...250V 50/60Hz 0.1...3 sec. 1...30 sec.	CRZE4-3S CRZE4-30S

① Auxiliary contact ratings per UL 508/NEMA (A600/Q600).

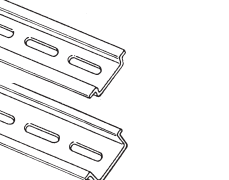
Accessories

Accessory	Product Description	Catalog Number
	<p>Surge Suppressor CRC4 For limiting voltage spikes when switching off coil. Coil itself provides sufficient limitation at voltages over 240 volts.</p> <p>RC Link (Type CRC4...): 24-48 VAC 110-280 VAC</p> <p>Diode Link (Type CRD4...): 12-250 VDC</p> <p>Varistor Link (Type CRV4...): 12-55 VAC/12-77 VDC 56-136 VAC/78-180 VDC 137-277 VAC/181-350 VDC</p>	<p>25.950.121-01 25.950.121-02</p> <p>25.950.123-02</p> <p>25.950.122-01 25.950.122-02 25.950.122-03</p>
	<p>Mechanical Interlock Kit For CS4(B) relays with AC coil. Not for use with DC coils.</p>	<p>25.951.301-01</p>
	<p>Adaptor For mounting CRZE4 and CRZY4 Electronic Timers to DIN Rails.</p>	<p>25.950.207-01</p>
	<p>Spade Connectors - Dual stab for coil terminals (0.250 inch) Package quantity 20</p>	<p>CA7-SC2</p>
	<p>DIN-rail - 2 meter lengths (≈6' 6") Top Hat, low profile (price per rail) Top Hat, high profile (price per rail)</p>	<p>3F 3AF</p>

Marking Systems

Component	Description	Pkg. Qty.	Catalog Number
	Label Sheet – 1 sheet with 105 self-adhesive paper labels each, 6 x 17mm	1	CA7-FMS
	Marking Tag Sheet - 1 sheet with 160 perforated paper labels each, 6 x 17mm. To be used with transparent cover.	1	CA7-FMP
	Transparent Cover - To be used with Marking Tag Sheets.	100 ①	CA7-FMC
	Tag Carrier - For marking with Series V7 Clip-on Tags.	100 ①	CA7-FMA2

OBSOLETE

① Minimum order quantity is one package of 100. Price each x 100 = total price.

Technical Information

			CS4	CS4-B	Auxiliary Contacts
			A600, Q600	A300, Q300	A600, Q600
Electrical					
Contact Ratings — NEMA					
Contact Ratings — IEC					
AC-15 (solenoids, contactors) at rated voltage IEC 947, EN 60947	12...120V	[A]	10	2.5	10
	220...240V	[A]	5	2.0	5
	360...400V	[A]	2.5	2.0	2.5
	480...500V	[A]	1.25	2.0	1.25
AC-1 (Non-inductive, or slightly inductive loads, resistance furnaces) IEC947, EN 60947	40°C	[A]	16	10	16
	60°C	[A]	12	6	12
AC-2, AC-3, AC-4 (switching 3Ø motors)	230V	[A]	5	5	~
	400V	[A]	3.7	3.7	~
	500V	[A]	2.8	2.8	~
Low Level Signal Switching					
Contact design			X-stamped	H-bridge bi-furcated	H-bridge bi-furcated
Minimum switching recommendation			17V 25mA	17V 5mA	17V 5mA
Short Circuit Protection afforded by relay					
Coordination Type 2 acc. IEC 947-4-1	Fuse gG	[A]	16	16	~
	Fuse aM	[A]	16	16	~
Switching DC					
Non-inductive or slightly inductive loads, resistance furnaces DC-1 at 60°C					
1 pole	24...48V	[A]	6 / 4	~	~
	110V	[A]	0.6	~	~
	220V	[A]	0.2	~	~
	440V	[A]	0.08	~	~
2 poles in series	24...48V	[A]	6	~	~
	110V	[A]	4	~	~
	220V	[A]	0.8	~	~
	440V	[A]	0.2	~	~
3 poles in series	24...48V	[A]	6	~	~
	110V	[A]	6	~	~
	220V	[A]	3	~	~
	440V	[A]	0.4	~	~
Ratings according to UL/CSA					
Operating voltage	AC	[V]	115	115	~
	AC	[V]	200	200	~
	AC	[V]	230	230	~
	AC	[V]	460	~	~
	AC	[V]	575	~	~
Cont. Rating (general purpose)	300V	[V]	12	10	~
	600V	[V]	12	10	~

Technical Information

CS4 / CS4-B Relays

Mechanical

Mechanical Life	[Mil]	10
------------------------	-------	----

Electrical Life

AC-15 (240V, 3A) AC Operations	[Mil]	~
AC-1 (230V, 6A)	[Mil]	0.7

Weight	[g]	153
---------------	-----	-----

Terminal Cross-Sections

Terminal Type



	1 Conductor	[mm ²]	0.75...2.5
	2 Conductor	[mm ²]	0.75...2.5
	1 Conductor	[mm ²]	0.75...2.5
	2 Conductor	[mm ²]	0.75...2.5

Max. Wire Size	[AWG]	18...14
-----------------------	-------	---------

Tightening Torque	[Nm]	1...1.5
	[lb-in]	7...15

Control Circuit

Operating Voltage

AC 50/60 Hz	Pickup	[x U]	0.85...1.1
	Dropout	[x U ^S]	0.35...0.65
DC	Pickup	[x U ^S]	0.8...1.1
	Dropout	[x U ^S]	0.1...0.25
with protection circuit	Dropout	[U _{max} /U _{min}] ^S	1...1.2

Coil Consumption

AC 50/60 Hz	Inrush	[VA/W]	22 / 20
	Seal	[VA/W]	4 / 1.4
DC	Inrush/Seal	[W]	2.5

Operating Times

AC- 50/60 Hz	Pickup Time	[ms]	15...40
	Dropout Time	[ms]	15...25
DC	Pickup Time	[ms]	18...40
	Dropout Time	[ms]	6...12
with protection circuit	Dropout	[ms]	8...12

General

Rated Voltage Withstand U

IEC	500V
UL; CSA	600V
High voltage - 1 minute (per IEC 947-4)	2500V

Rated Impulse Strength U_{imp}	8 kV
---	------

Rated Voltage U_e

AC	230, 240, 400, 415, 500V
DC	24, 48, 110, 220, 440V

Rated Frequency	50/60 Hz, DC
------------------------	--------------

Ambient Temperature

Storage	-55...+80°C (-67...176°F)
Operation at nominal current	-25...+60°C (-13...140°F)
At 85% rated operation current	-25...+70°C (-13... 158°F)

Resistance to Climatic Change	40° C (104° F), 95% relative humidity, 56 days
	23° C (73.4 ° F), 83%/40 ° C (104 ° F), 93%, 56 cycles

Altitude	2000m M.S.L., per IEC 947-4
-----------------	-----------------------------

Type of Protection

IP 20 (IEC 529 and DIN 40050)	in connected state
-------------------------------	--------------------

Finger Protection

safe from touch by fingers and back of hand per VDE 0106, Part 100

CRZE4/CRZY4 Electronic Timers

Permissible voltage

CRZE4 (AC or DC)	110V (-23%) - 250V (+10%)
CRZY4 (AC only)	110V (-23%) - 120V (+10%)
	220V (-20%) - 250V (+10%)

Voltage drop	5V max
---------------------	--------

Load current for reliable operation	10mA min
--	----------

Load current

20°C (68° F)	600mA
40°C (104° F)	440mA
55°C (131° F)	320mA

Leakage current at 220V

CRZE4	5mA
CRZY4	"Y" 17mA, "Δ" 6mA

Reset time	≥200ms
-------------------	--------

Voltage failure duration having no influence on timing sequence

CRZE4	15ms
CRZY4	≥20ms

Repeat accuracy

At fixed temperature	±1%
With temperature range of 5...+55°C (+23...+131° F)	±5%

Time interval for start commands

CRZE4	1.4 x set time
CRZY4	2 x set time

Ambient temperature

Storage	-40°C to +80°C (-40...+176° F)
Operation	-20°C to +55°C (-4...+131° F)

Terminals: 0.8 mm² (AWG 18)

CRZE4	2 free cable ends, each 250 mm long
CRZY4	4 free cable ends, each 250 mm long

Series CS4 & CS4-B Industrial Control Relays

- Dimensions are in millimeters (inches)
- Dimensions not intended for manufacturing purposes

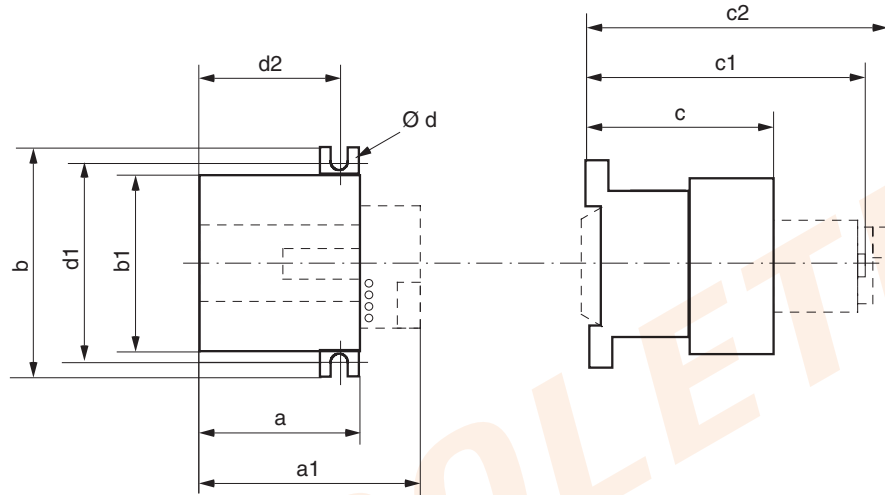

Type	a	a1	b	b1	c	c1	c2	Ød	d1	d2
CS4(B) (AC & DC)	45 (1-25/32)	67 (2-21/32)	56 (2-3/16)	47 (1-14/16)	48 (1-29/32)	74 (2-15/16)	77 (3-1/16)	4.2 (11/64)	50 (1-31/32)	40 (1-9/16)

Relays & Accessories

Relay with...		Dim. [mm]	Dim. [inches]
with aux. contact block		c1	c1
with timer	on relay	c2	c2
	at side of relay	a1	a1
with neutral terminal	at side of relay	a+20	a + 1-25/32
with protection element		c2	c2
with nameplate		c..+5	c..+ 3/16

Mounting Position

