

**Ground Path**

To reduce the likelihood of electrical shock, the National Electrical Code requires that non-current carrying metallic components be grounded. Insulgrip Pin and Sleeve wiring devices offer two styles of grounding.

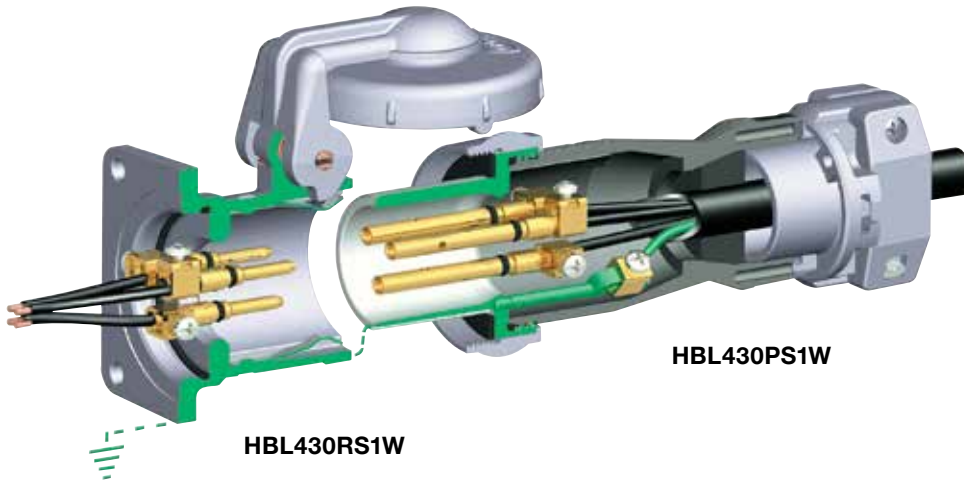

**Style I**

Receptacles achieve grounding by attaching the ground conductor to the ground screw inside the back box and utilizing the metallic receptacle shell as a ground source (see 3P 4W Style I illustration). Plugs and connectors establish grounding by means of connecting the flexible cable ground conductor to a ground terminal within each device, which, in turn, is grounded through the metallic plug or connector shroud. Any exposed metallic components are suitably grounded in the Style I offering.

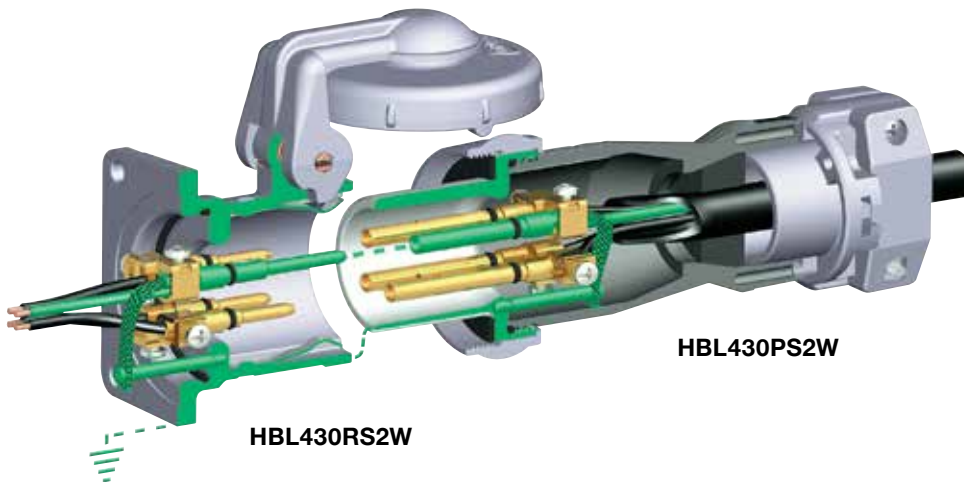

**Style II**

The Style II ground path offers two means of achieving the proper ground path. In addition to utilizing the same grounding method as in the Style I product, the Style II version incorporates a separate ground pin and sleeve (see 3P 4W Style II illustration). This provides a second ground path. The ground pin on Style II devices is longer than other pins, meaning that they “make first” and “break last,” assuring protection for people and equipment.

**New Pole and Wire Terminology**

Style I			Style II		
New	Old	No. of Contacts	New	Old	No. of Contacts
2P 3W	2W 2P	2	2P 3W	2W 3P	3
3P 4W	3W 3P	3	3P 4W	3W 4P	4
4P 5W	4W 4P	4			

# UL 1686 C1 Pin and Sleeve

## Insulgrip® Pin and Sleeve Devices

Features and Benefits

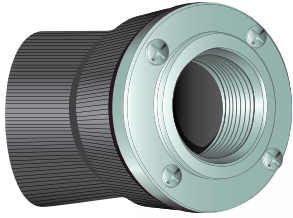

**Liquidtight Conduit Adapters**  
Machined aluminum adapters are available to provide a means for attaching flexible liquidtight metal conduit to rear of Hubbell Pin and Sleeve plug or connector

**Watertight Neoprene Sealing Glands**  
Provide a reliable seal at the cable entry point

**Lid-Stay**  
Provides a hands-free means of holding the cover in the open position for engaging mating device, troubleshooting or maintenance purpose

**Spring-Loaded, Gasketed Cover**  
Provides a UL Type 4X watertight, dust-tight seal on connectors and receptacles

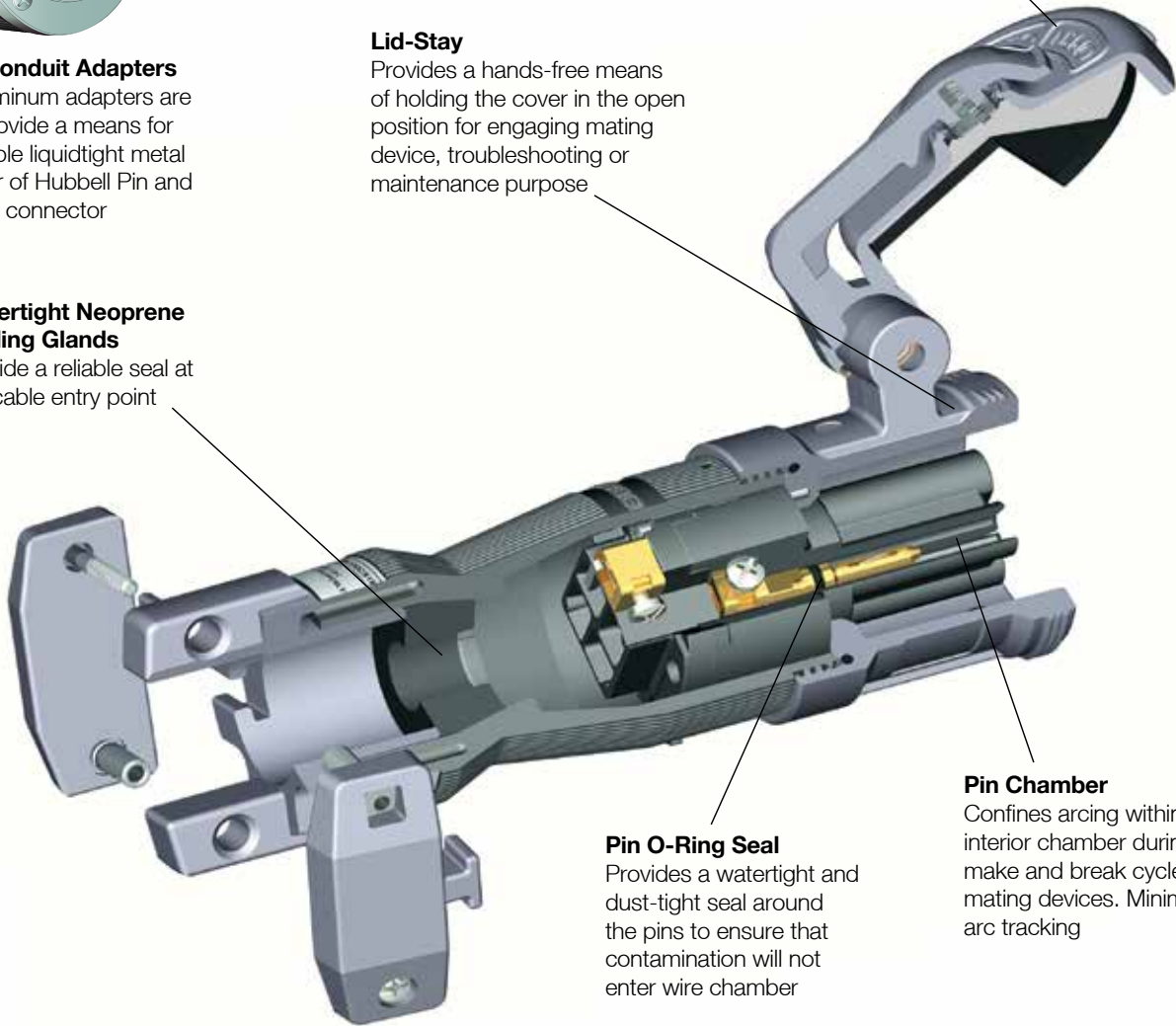

**Pin O-Ring Seal**  
Provides a watertight and dust-tight seal around the pins to ensure that contamination will not enter wire chamber

**Pin Chamber**  
Confines arcing within the interior chamber during make and break cycle of mating devices. Minimizes arc tracking



**Powerful Mechanical Cord Grip**  
Hubbell's design incorporates two molded-in teeth to securely grip the outer cable jacket, and internal conductors to prevent slippage and strain on terminations. Captive barrel nuts ease assembly and allow higher tightening torque for maximum cord retention.



**Watertight Cord Entrance**  
The tapered bore entrance creates high compression forces on sealing gland, providing a watertight seal around cord. Individual solid neoprene glands are supplied to match a full range of cord sizes and assure watertight performance.



**Anti-Vibration Box Terminals**  
Interlocking box terminals ensure that terminal screws remain secure and cannot loosen. The floating box is designed to obtain high-torque values without damaging stranded conductors.



**Terminal Entrance Holes**  
Large, square funneled entrance holes isolate each conductor to protect against shorts due to stray conductor strands. Tapered hole provides a fast and easy guide into the termination chamber.

UL 1686 C1 Pin and Sleeve  
**Insulgrip® Pin and Sleeve Devices**  
*Features and Benefits*

**Locking Ring**

Provides a UL Type 4X watertight and dust-tight seal when the male and female devices are connected

**Sleeve O-Ring Seal**

Provides a watertight and dust-tight seal around the sleeves. Assures that contamination will not enter wire chamber

**Product Marking**

Catalog number and rating visible while in use. Markings are color coded differentiating Style I and Style II devices

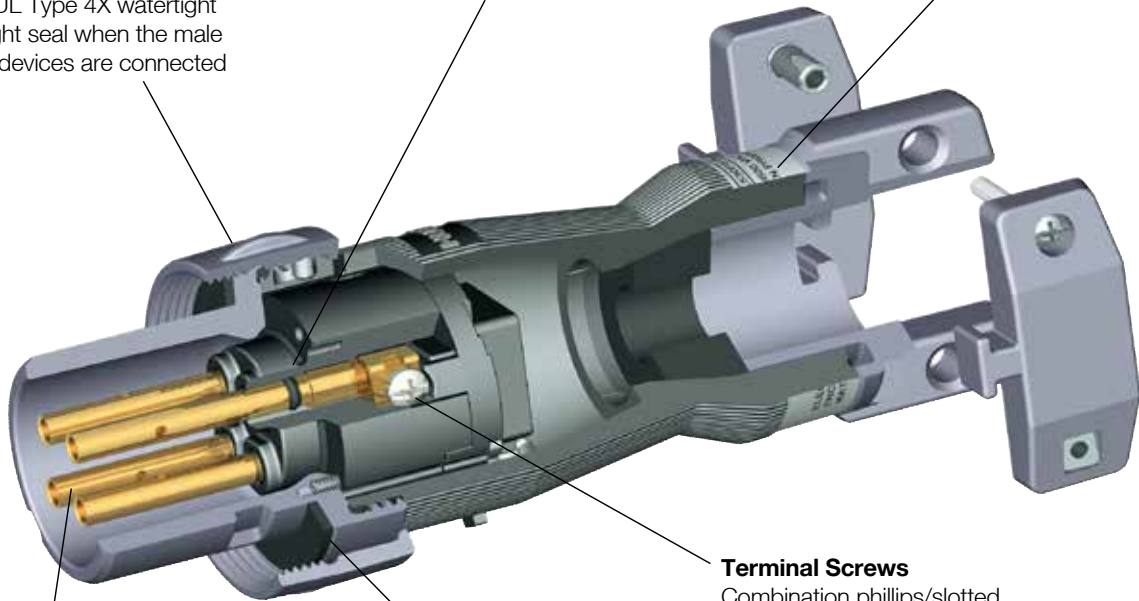

**Terminal Screws**

Combination phillips/slotted head design

**Shroud/Housing Seal**

Provides a watertight and dust-tight seal when mated with receptacle or connector

**All-Brass Sleeve Contacts**

Provide reliable electrical contact with mating pins. Ensures reliable electrical contact with minimum heat build-up over time



**Thermoplastic Housing**

Provides excellent insulating, impact, corrosion, and UV resistant properties. Protects users and internal components in the roughest of environments.

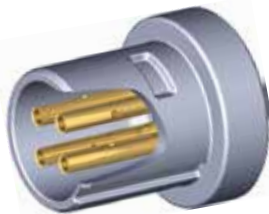

**Shrouded Sleeves**

The shroud protects contact sleeves from deforming from physical abuse. The design protects the user from the possibility of touching live contacts during insertion and withdrawal of mating parts.

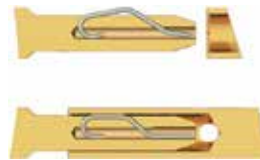

















**Beryllium Copper Spring-Pin Design (Patented)**









Maintains high unit pressure on mating sleeves. Ensures reliable electrical contact while minimizing heat rise due to normal pin wear over time.









**Thermoset Polyester Contact Carrier**

Molded thermoset polyester provides high resistance to electrical tracking. Withstands higher temperatures which may result from overload or arcing. Thermoset properties provide dimensional stability for this critical assembly.

Rating				Style I Devices			Replacement Interiors	
Amps	Poles and Wires	Receptacle/ Connector Configuration*	Maximum Voltage AC/DC	 Receptacle	 Plug	 Connector	 Connector & Receptacle	 Plug
30	2P 3W		600/250	<b>HBL330RS1W</b>	<b>HBL330PS1W</b>	<b>HBL330CS1W</b>	<b>IN330FS1</b>	<b>IN330MS1</b>
	3P 4W		600/250	<b>HBL430RS1W</b>	<b>HBL430PS1W</b>	<b>HBL430CS1W</b>	<b>IN430FS1</b>	<b>IN430MS1</b>
	4P 5W		600/250	<b>HBL530RS1W</b>	<b>HBL530PS1W</b>	<b>HBL530CS1W</b>	<b>IN530FS1</b>	<b>IN530MS1</b>
60	2P 3W		600/250	<b>HBL360RS1W</b>	<b>HBL360PS1W</b>	<b>HBL360CS1W</b>	<b>IN360FS1</b>	<b>IN360MS1</b>
	3P 4W		600/250	<b>HBL460RS1W</b>	<b>HBL460PS1W</b>	<b>HBL460CS1W</b>	<b>IN460FS1</b>	<b>IN460MS1</b>
	4P 5W		600/250	<b>HBL560RS1W</b>	<b>HBL560PS1W</b>	<b>HBL560CS1W</b>	<b>IN560FS1</b>	<b>IN560MS1</b>
100	2P 3W		600/250	<b>HBL3100RS1W</b>	<b>HBL3100PS1W</b>	<b>HBL3100CS1W</b>	<b>IN3100FS1</b>	<b>IN3100MS1</b>
	3P 4W		600/250	<b>HBL4100RS1W</b>	<b>HBL4100PS1W</b>	<b>HBL4100CS1W</b>	<b>IN4100FS1</b>	<b>IN4100MS1</b>
	4P 5W		600/250	<b>HBL5100RS1W</b>	<b>HBL5100PS1W</b>	<b>HBL5100CS1W</b>	<b>IN5100FS1</b>	<b>IN5100MS1</b>
200	3P 4W		600/250	<b>HBL4200RS1W</b>	<b>HBL4200PS1W</b>	<b>HBL4200CS1W</b>	<b>IN4200FS1†</b>	<b>IN4200MS1†</b>
	4P 5W		600/250	<b>HBL5200RS1W</b>	<b>HBL5200PS1W</b>	<b>HBL5200CS1W</b>	<b>IN5200FS1†</b>	<b>IN5200MS1†</b>

Rating				Style II Devices			Replacement Interiors	
Amps	Poles and Wires	Receptacle/ Connector Configuration*	Maximum Voltage AC/DC	Receptacle	Plug	Connector	Connector & Receptacle	Plug
30	2P 3W		600/250	<b>HBL330RS2W</b>	<b>HBL330PS2W</b>	<b>HBL330CS2W</b>	<b>IN330FS2</b>	<b>IN330MS2</b>
	3P 4W		600/250	<b>HBL430RS2W</b>	<b>HBL430PS2W</b>	<b>HBL430CS2W</b>	<b>IN430FS2</b>	<b>IN430MS2</b>
60	2P 3W		600/250	<b>HBL360RS2W</b>	<b>HBL360PS2W</b>	<b>HBL360CS2W</b>	<b>IN360FS2</b>	<b>IN360MS2</b>
	3P 4W		600/250	<b>HBL460RS2W</b>	<b>HBL460PS2W</b>	<b>HBL460CS2W</b>	<b>IN460FS2</b>	<b>IN460MS2</b>
100	2P 3W		600/250	<b>HBL3100RS2W</b>	<b>HBL3100PS2W</b>	<b>HBL3100CS2W</b>	<b>IN3100FS2</b>	<b>IN3100MS2</b>
	3P 4W		600/250	<b>HBL4100RS2W</b>	<b>HBL4100PS2W</b>	<b>HBL4100CS2W</b>	<b>IN4100FS2</b>	<b>IN4100MS2</b>
200	2P 3W		600/250	<b>HBL3200RS2W</b>	<b>HBL3200PS2W</b>	<b>HBL3200CS2W</b>	<b>IN3200FS2†</b>	<b>IN3200MS2†</b>
	3P 4W		600/250	<b>HBL4200RS2W</b>	<b>HBL4200PS2W</b>	<b>HBL4200CS2W</b>	<b>IN4200FS2†</b>	<b>IN4200MS2†</b>

















Rating				Corrosion Resistant Devices			Accessories	
Amps	Poles and Wires	Receptacle/ Connector Configuration*	Maximum Voltage AC/DC	 Receptacle	 Plug	 Connector	 Back Boxes	 Angle Adapter
200	4P 5W		600/250	<b>M5200RS1</b>	<b>M5200PS1</b>	<b>M5200CS1</b>	<b>MB2003W</b> <b>MB2004W</b>	<b>AA20045</b>









Note: **\*CAUTION:** To avoid electrical shock, review premises carefully and DO NOT use if Pin and Sleeve configuration (design) is already in a circuit having a rating differing from the rating of this device.





\*\*While in use or with cover closed.

†Consult factory.

Corrosion resistant cord sets are available on page Y-17 of this catalog.

Rating				Style I Devices			Replacement Interiors	
Amps	Poles and Wires	Receptacle/ Connector Configuration*	Maximum Voltage AC/DC	 Receptacle	 Plug	 Connector	 Connector & Receptacle	 Plug
30	2P 3W		600/250	HBL330RS1WR	HBL330PS1WR	HBL330CS1WR	IN330MS1	IN330FS1
	3P 4W		600/250	HBL430RS1WR	HBL430PS1WR	HBL430CS1WR	IN430MS1	IN430FS1
	4P 5W		600/250	HBL530RS1WR	HBL530PS1WR	HBL530CS1WR	IN530MS1	IN530FS1
60	2P 3W		600/250	HBL360RS1WR	HBL360PS1WR	HBL360CS1WR	IN360MS1	IN360FS1
	3P 4W		600/250	HBL460RS1WR	HBL460PS1WR	HBL460CS1WR	IN460MS1	IN460FS1
	4P 5W		600/250	HBL560RS1WR	HBL560PS1WR	HBL560CS1WR	IN560MS1	IN560FS1
100	2P 3W		600/250	HBL3100RS1WR	HBL3100PS1WR	HBL3100CS1WR	IN3100MS1	IN3100FS1
	3P 4W		600/250	HBL4100RS1WR	HBL4100PS1WR	HBL4100CS1WR	IN4100MS1	IN4100FS1
	4P 5W		600/250	HBL5100RS1WR	HBL5100PS1WR	HBL5100CS1WR	IN5100MS1	IN5100FS1
200	3P 4W		600/250	HBL4200RS1WR	HBL4200PS1WR	HBL4200CS1WR	IN4200MS1†	IN4200FS1†
	4P 5W		600/250	HBL5200RS1WR	HBL5200PS1WR	HBL5200CS1WR	IN5200MS1†	IN5200FS1†

Rating				Style II Devices			Replacement Interiors	
Amps	Poles and Wires	Receptacle/ Connector Configuration*	Maximum Voltage AC/DC	Receptacle	Plug	Connector	Connector & Receptacle	Plug
30	2P 3W		600/250	HBL330RS2WR	HBL330PS2WR	HBL330CS2WR	IN330MS2	IN330FS2
	3P 4W		600/250	HBL430RS2WR	HBL430PS2WR	HBL430CS2WR	IN430MS2	IN430FS2
60	2P 3W		600/250	HBL360RS2WR	HBL360PS2WR	HBL360CS2WR	IN360MS2	IN360FS2
	3P 4W		600/250	HBL460RS2WR	HBL460PS2WR	HBL460CS2WR	IN460MS2	IN460FS2
100	2P 3W		600/250	HBL3100RS2WR	HBL3100PS2WR	HBL3100CS2WR	IN3100MS2	IN3100FS2
	3P 4W		600/250	HBL4100RS2WR	HBL4100PS2WR	HBL4100CS2WR	IN4100MS2	IN4100FS2
200	2P 3W		600/250	HBL3200RS2WR	HBL3200PS2WR	HBL3200CS2WR	IN3200MS2†	IN3200FS2†
	3P 4W		600/250	HBL4200RS2WR	HBL4200PS2WR	HBL4200CS2WR	IN4200MS2†	IN4200FS2†

Rating				Corrosion Resistant Devices			Accessories	
Amps	Poles and Wires	Receptacle/ Connector Configuration*	Maximum Voltage AC/DC	 Receptacle	 Plug	Connector	 Back Boxes	 Angle Adapter
200	4P 5W		600/250	M5200BS1R	M5200CS1R	—	MB2003W MB2004W	AA20045

Note: **CAUTION:** To avoid electrical shock, review premises carefully and DO NOT use if Pin and Sleeve configuration (design) is already in a circuit having a rating differing from the rating of this device.

\*\*While in use or with cover closed.

†Consult factory.

Corrosion resistant cord sets are available on page Y-17 of this catalog.

# UL 1686 C1 Pin and Sleeve Insulgrip® Pin and Sleeve Device Dimensions

## Receptacle Dimensions

Amps	Type	A		B		C		D		E	
		Style I	Style II	Style I	Style II	Style I	Style II	Style I	Style II	Style I	Style II
30	330R	2.72" (69)	2.72" (69)	3.40" (86)	3.40" (86)	3.89" (99)	3.89" (99)	3.19" (81)	3.19" (81)	1.37" (35)	1.37" (35)
	430R	2.72" (69)	2.72" (69)	3.40" (86)	3.40" (86)	3.89" (99)	3.89" (99)	3.19" (81)	3.19" (81)	1.37" (35)	1.37" (35)
	530R	2.72" (69)		3.40" (86)		3.89" (99)		3.19" (81)		1.37" (35)	
60	360R	3.50" (89)	3.50" (89)	4.25" (108)	4.25" (108)	4.66" (118)	4.66" (118)	4.42" (112)	4.42" (112)	1.54" (39)	1.54" (39)
	460R	3.50" (89)	3.50" (89)	4.25" (108)	4.25" (108)	4.66" (118)	4.66" (118)	4.42" (112)	4.42" (112)	1.54" (39)	1.54" (39)
	560R	3.50" (89)		4.25" (108)		4.66" (118)		4.42" (112)		1.54" (39)	
100	3100R	3.50" (89)	3.50" (89)	4.25" (108)	4.25" (108)	4.66" (118)	4.70" (119)	5.30" (135)	5.30" (135)	1.54" (39)	1.54" (39)
	4100R	3.50" (89)	3.50" (89)	4.25" (108)	4.25" (108)	4.66" (118)	4.70" (119)	5.30" (135)	5.30" (135)	1.54" (39)	1.54" (39)
	5100R	3.50" (89)		4.25" (108)		4.66" (118)		5.30" (135)		1.54" (39)	
200	3200R		6.50" (165)		7.00" (177)		5.63" (143)		7.76" (197)		.99" (25)
	4200R	6.50" (165)	6.90" (170)	7.00" (177)	7.39" (187)	5.63" (143)	5.63" (143)	7.76" (197)	7.76" (197)	.99" (25)	.99" (25)
	5200R	6.90" (170)		7.39" (187)		5.63" (143)		7.76" (197)		.99" (25)	

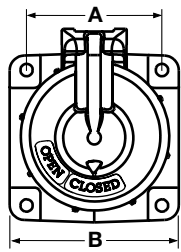

30, 60 and 100 Amp

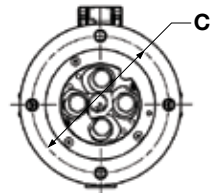
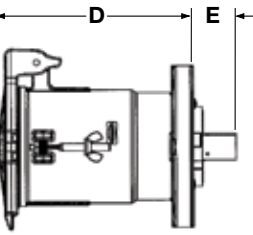
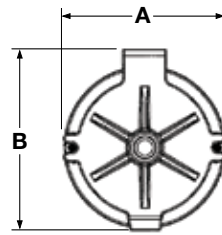
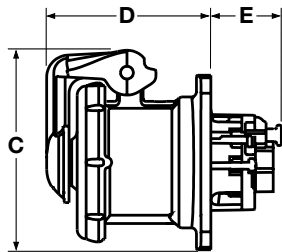

200 Amp

## Plug Dimensions

Amps	Type	A		B		Cord Grip Range
		Style I	Style II	Style I	Style II	
30	330P	7.53" (191)	7.53" (191)	3.00" (76)	3.00" (76)	.375-1.20" (9.5-30.5)
	430P	7.53" (191)	7.53" (191)	3.00" (76)	3.00" (76)	.375-1.20" (9.5-30.5)
	530P	7.53" (191)		3.00" (76)		.375-1.20" (9.5-30.5)
60	360P	9.40" (239)	9.40" (239)	3.40" (86)	3.40" (86)	.500-1.45" (12.7-36.8)
	460P	9.40" (239)	9.40" (239)	3.40" (86)	3.70" (94)	.500-1.45" (12.7-36.8)
	560P	9.40" (239)		3.70" (94)		.500-1.45" (12.7-36.8)
100	3100P	10.70" (272)	10.70" (272)	3.70" (94)	3.70" (94)	.925-1.94" (27.0-49.3)
	4100P	10.70" (272)	10.90" (277)	3.70" (94)	4.00" (102)	.925-1.94" (27.0-49.3)
	5100P	10.90" (277)		4.00" (102)		.925-1.94" (27.0-49.3)
200	3200P		11.13" (282)		6.35" (161)	1.00-2.50" (25.4-63.5)
	4200P	11.13" (282)	11.13" (282)	6.35" (161)	6.70" (170)	1.00-2.50" (25.4-63.5)
	5200P	11.13" (282)		6.70" (170)		1.00-2.50" (25.4-63.5)

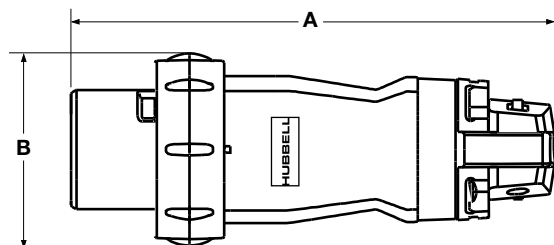

## Connector Body Dimensions

Amps	Type	A		B		Cord Grip Range
		Style I	Style II	Style I	Style II	
30	330C	8.38" (213)	8.38" (213)	3.74" (95)	3.74" (95)	.375-1.20" (9.5-30.5)
	430C	8.38" (213)	8.38" (213)	3.74" (95)	3.74" (95)	.375-1.20" (9.5-30.5)
	530C	8.38" (213)		3.74" (95)		.375-1.20" (9.5-30.5)
60	360C	9.90" (251)	9.90" (251)	3.50" (89)	3.50" (89)	.500-1.45" (12.7-36.8)
	460C	9.90" (251)	10.10" (256)	3.50" (89)	3.80" (96)	.500-1.45" (12.7-36.8)
	560C	10.10" (256)		3.80" (96)		.500-1.45" (12.7-36.8)
100	3100C	11.70" (297)	11.70" (297)	4.50" (114)	4.50" (114)	.925-1.94" (27.0-49.3)
	4100C	11.70" (297)	11.90" (302)	4.50" (114)	4.70" (119)	.925-1.94" (27.0-49.3)
	5100C	11.90" (302)		4.70" (119)		.925-1.94" (27.0-49.3)
200	3200C		13.65" (346)		7.00" (177)	1.00-2.50" (25.4-63.5)
	4200C	13.65" (346)	13.65" (346)	7.00" (177)	7.39" (187)	1.00-2.50" (25.4-63.5)
	5200C	13.65" (346)		7.39" (187)		1.00-2.50" (25.4-63.5)

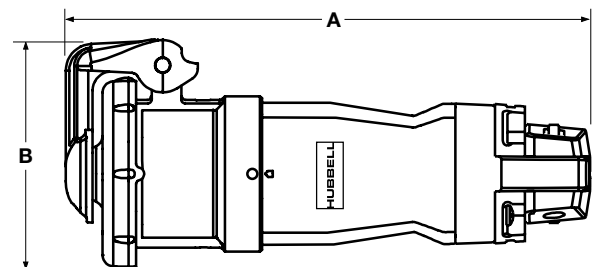

Dimensions in Inches (mm)

**Materials (30, 60, 100, and 200 Amp)**

Plug	Material
Housing	Valox® 357 (200A Aluminum)
Plug Shroud	Aluminum
Cord Clamps	Rynite® SST35 (200A Aluminum)
Clamp Nut	Nickel Plated Brass
Gland Cap	Rynite® SST35
Gland	Neoprene
O-Rings, Gaskets & Seals	Neoprene
Contact Carrier	Thermoset Polyester
Retainer	Thermoset Polyester
Sleeves	Brass (M-Series - Nickel-plated tellurium copper)
Box Terminal	Heat Treated & Zinc Plated Steel
Screws (Terminal, Assembly & Set)	Stainless Steel (300 Series)
Ground Standoff	Brass
Ground Bracket	Nickel Plated Spring Bronze
Locking Ring	Epoxy Painted Aluminum
<b>Connector Body</b>	
Housing	Valox® 357 (200 Amp Aluminum)
Connector Shroud	Epoxy Painted Aluminum
Cord Clamps	Rynite® SST35
Clamp Nut	Nickel Plated Brass
Gland Cap	Rynite® SST35 (200A Aluminum)
Gland	Neoprene
O-Rings, Gaskets & Seals	Neoprene
Contact Carrier	Thermoset Polyester
Retainer	Thermoset Polyester
Pin	Brass (M-Series - Nickel-plated tellurium copper)
Pin Spring	Beryllium Copper
Box Terminal	Heat Treated & Zinc Plated Steel
Screws (Terminal, Assembly & Set)	Stainless Steel (300 Series)
Ground Standoff	Brass
Ground Bracket	Nickel Plated Spring Bronze
Cover	Epoxy Painted Aluminum
Cover Arm	Epoxy Painted Aluminum
Spring Guide	Stainless Steel (300 Series)
Springs (Arm & Wave)	Stainless Steel (300 Series)
Spring Washer	Stainless Steel (300 Series)
Hinge Bushing	Aluminum
Rivet	Aluminum
<b>Receptacle</b>	
Housing/Flange	Epoxy Painted Aluminum
O-Rings, Gaskets & Seals	Neoprene
Contact Carrier	Thermoset Polyester
Retainer	Thermoset Polyester
Pin	Brass (M-Series - Nickel-plated tellurium copper)
Pin Spring	Beryllium Copper
Box Terminal	Heat Treated & Zinc Plated Steel
Screws (Terminal, Assembly & Set)	Stainless Steel (300 Series)
Ground Standoff	Brass
Ground Bracket	Steel
Cover	Epoxy Painted Aluminum
Cover Arm	Epoxy Painted Aluminum
Spring Guide	Stainless Steel (300 Series)
Springs (Arm & Wave)	Stainless Steel (300 Series)
Spring Washer	Stainless Steel (300 Series)
Hinge Bushing	Aluminum
Rivet	Aluminum

**Typical Specification**

Manufacturer's ID	Hubbell HBL430PS2W
Description	Plug, Power Supply
Electrical Type	3 Pole + Earth
Max. Rating	30 Amp, 600V AC, 250V DC, 50-400Hz
Configuration	UL 1686, Watertight, C1 Configuration
Certification	UL Listed, UL Standard 1682, UL 50, and UL 1010 (plugs only), CSA Certified to CSA Spec. C22.2 No. 182.1, No. 94 and No. 159 (plugs only), UL Listed and CSA Certified Type 4X

**Performance**

<b>Electrical</b>	
Dielectric Voltage	Withstands 3,000V AC.
Max. Working Voltage	600V AC RMS (i.e., minimum creepage and clearance distance of 6.4 millimeters, per UL 1682).
Current Interrupting	Certified for current interrupting at full rated current.
Temperature Rise	Max. 30°C temperature rise at full rated current after 50 cycles of overload at 150% of rated current.
Endurance	Up to 1,000 connect and disconnect cycles at full rated current and voltage.
<b>Mechanical</b>	
Impact Resistance	Per CSA C22.2, No. 182.1, UL 1682.
Cord Grip Cable Retention	Per CSA C22.2, No. 182.1, UL 1682.
Cord Accommodation	Round portable service cords of diameters commensurate with the device rating as defined in UL Standard 62, CSA C22.2 No. 49 and the harmonized <HAR> European Standards.
Terminal Identification	Terminals identified in accordance with UL 1686 (1, 2, 3, Green).
Product Identification	Identification and ratings are permanently fastened to the device housing.

<b>Environmental</b>	
Hose Down & Moisture Resistance	Type 3, 4, 4X per UL 50E and CSA 22.2, No. 94.
Flammability (Enclosure)	UL 94V-0 and CSA C22.2 No. 0.17.
Operating Temperatures	Maximum Continuous 75°C; Minimum -40°C without impact -25° with impact.
Hazardous Location (30, 60 & 100A) (plug only)	Class I, Division I & II, Groups B, C & D and Class II, Division I & II, Groups F & G per UL 1010 & CSA 22.2, No. 159.

<b>Materials</b>	
Housings	Valox® 357 (200A Aluminum).
All Other Materials	Resistant to corrosion and chemical attack.

**Watertight Application Guide**

Industry	Watertight.
Agriculture	Outdoor for fans, heaters, pumps, etc.
Chemical Processing	Where subject to water, corrosion.
Construction	Outdoors subject to severe weather conditions.
Entertainment	Outdoors subject to severe weather.
Food Processing	Where subject to water, corrosion.
Food Service	Areas subject to wash downs & heavy cleaning.
Light Manufacturing	Subjected to cleaning, solvents & chemicals.
Manufacturing	Where subject to water, corrosion.
Military	Outdoor construction or maintenance.

*Valox® is a trademark of SABIC Innovative Plastics, acquired from General Electric Company. Rynite® is a registered trademark of E.I. DuPont Corp.*